

Comprehensive temperature control of a hot metal rolling thickness measurement system

SERGEY V. DVOYNISHNIKOV, VITALY V. RAHMANOV, VLADIMIR A. PAVLOV AND
STANISLAV V. KROTOV

Kutateladze Institute of thermophysics SB RAS
Novosibirsk
RUSSIAN FEDERATION

Abstract: - The work is devoted to the development of integrated thermostating subsystem of a high-precision system for measuring the thickness of hot metal rolling. The developed thermostating subsystem includes active and passive modules, which ensured thermostability of the measuring modules at the level of 0.5 degrees in a hot metallurgical workshop. Thermal stabilization made it possible to ensure high accuracy in measuring the thickness of hot metal rolling in a hot metallurgical production workshop.

Key-Words: - temperature control, thickness measurement, hot metal rolling.

Received: November 8, 2019. Revised: April 11, 2020. Accepted: April 22, 2020. Published: May 12, 2020.

1 Introduction

Systems measuring the thickness of hot metal rolling are designed to operate in hot metallurgical production [1-3]. The operating conditions of the measuring system are complicated by extremely severe temperature effects: the temperature drops in the hot shop can reach 80 degrees during the day. Moreover the temperature directly in the measurement zone, where measuring system is located, changes by several hundred degrees within a minute.

The stability of the triangulation meter depends on the distance between the radiation source and receiver. In the case of temperature fluctuations of the entire measuring system, due to thermal expansion, the distances between the optical elements of the triangulation sensor will change in accordance with the law of linear thermal expansion:

$$l = l_0(1 + \alpha\Delta T) \quad (1)$$

As a result, fluctuations in the indications of the measuring system will be observed. Thus, for the precision operation of triangulation methods in hot metallurgy, it is necessary to ensure the temperature stability of the measuring system at the required high level.

To reduce the measurement error of optoelectronic systems, passive temperature stabilization methods are used [4-5] to deal with thermal influences (algorithmic thermal compensation, thermal shunting of elements, design improvements, etc.). However, in the most difficult

operating conditions, only passive methods are not enough [6-7]. In these cases, active methods are used, consisting in the creation of single- or multi-circuit reversible thermal control systems [8-10].

In this paper, an integrated approach to the thermal stabilization of the measuring system in the conditions of hot metallurgical work is proposed. The developed thermal stabilization subsystem includes active and passive thermostabilizing modules, which ensure the temperature stability of optical measuring elements with high accuracy.

2 Method description

To ensure the required metrological characteristics of the measuring system, a thermostating subsystem was created to provide stabilization of the temperature of the measuring system. The thermostating subsystem includes passive and active modules, which provide reduction of heat transfer between the environment and triangulation modules of the measuring system and stabilization of the temperature of the measuring system during operation.

The passive thermostat subsystem module provides thermal insulation of the measuring system and reduces heat transfer between the measuring modules and the environment [11-13]. The scheme of operation of the passive module is shown in Fig. 1. The system measures the thickness of the hot metal rolling 1 using optical modules 2 located in the upper and lower parts of the measuring system. It consists of a heat-insulating case 3, a protective case 4, a forced air circulation unit 5. The heat-insulating case has a reduced thermal conductivity and protects the optical modules from radiation and

convective heating. The temperature of the optical modules and the isothermal base is stabilized by a liquid thermostat 6 of the active thermal stabilization subsystem. The protective cover protects the measuring system from heating through radiation from the surface of the hot metal. Forced air circulation in the channel between the protective and heat-insulating cases provides a significant reduction in convective heat exchange between the protective and heat-insulating cases due to air circulation with a temperature equal to the average temperature in the room.

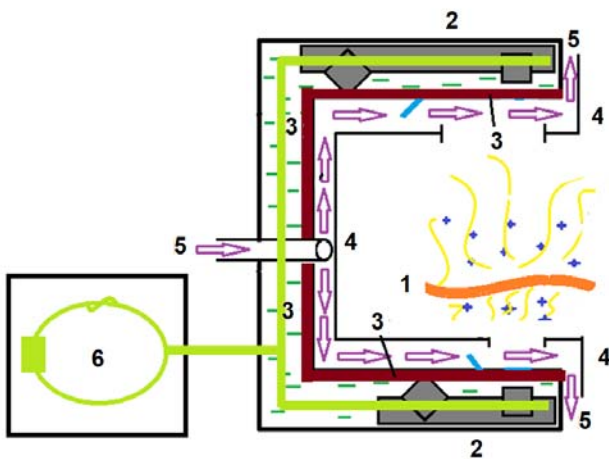

Fig. 1. Functional diagram of the thermal stabilization subsystem.

The main function of the active module of the thermal stabilization subsystem of the measuring system is to ensure a constant temperature of the measuring system during its operation. The main functional unit is an active liquid thermostat. Temperature stabilization is achieved by continuous circulation of the liquid coolant with given temperature through the heat exchange circuit of the meter. The coolant temperature is maintained at a given level using an external thermostat operating according to the algorithm of the proportional-integral-differential controller (PID controller) [14-16]. The equation of operation of the PID controller:

$$U(t) = K_p e(t) + \frac{1}{K_I} \int_0^t e(\tau) d\tau + K_D \left. \frac{de(\tau)}{d\tau} \right|_{\tau=t}, \quad (2)$$

where $U(t)$ is the regulatory action, $e(t)$ is the mismatch (regulation error), K_p, K_I, K_D are constant coefficients, t is time. The difference

scheme for the implementation of equation (2) is as follows:

$$U^k = S_p^k + S_I^k + S_D^k \quad (3)$$

$$S_p^k = K_p \cdot e^k \quad (4)$$

$$S_I^k = S_I^{k-1} + \frac{e^k + e^{k-1}}{2} \cdot \frac{\Delta t}{K_I} \quad (5)$$

$$S_D^k = K_D \cdot \frac{e^k - e^{k-1}}{\Delta t}, \quad (6)$$

where U^k - regulatory action at the k -th step, Δt is the time between two consecutive steps, e^k is the mismatch at the k -th step, S_p^k, S_I^k, S_D^k are the proportional, integral and differential terms, respectively.

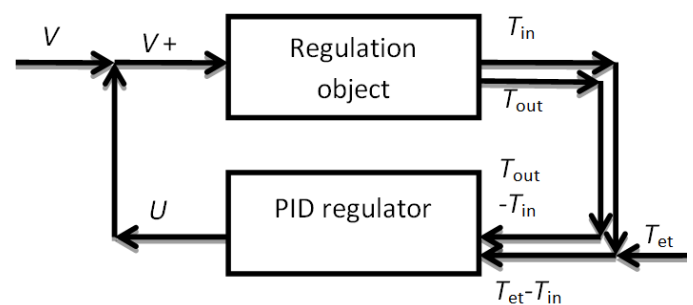

Fig. 2. The scheme of the regulation algorithm

The algorithm is implemented as shown on Fig. 2. The temperature sensors T_{in} and T_{out} are taken from the control object. The user sets the required temperature of the thermostat. The values of ΔT_1 and ΔT_2 are fed to the controller input:

$$\Delta T_1 = T_{out} - T_{in}, \quad (7)$$

$$\Delta T_2 = T_{et} - T_{in}. \quad (8)$$

These values are interpreted as spatial gradient inside the thermostat and the mismatch of the current and set temperatures. The temperature controller, taking into account the magnitude of the spatial gradient (comparing it with the permissible error), calculates the regulatory effect according to the formula (2). Thus, the effect of the regulator on

the object comes down to the fact that $\Delta T_1 \rightarrow 0$ and $\Delta T_2 \rightarrow 0$:

$$e^k = \Delta T_1^k + \Delta T_2^k . \quad (9)$$

This approach ensures the correct operation of the regulator both in heating and cooling mode. If it is necessary to heat the circuit, than $U(t) > 0$ and the thermostat turns on the heating power. If cooling is necessary, than $U(t) < 0$ and the controller opens the cooling circuit tap. As a result, the controller operates correctly in heating and cooling mode.

3 Practical implementation

The comprehensive temperature control system layout and connection scheme are shown on figure 3.

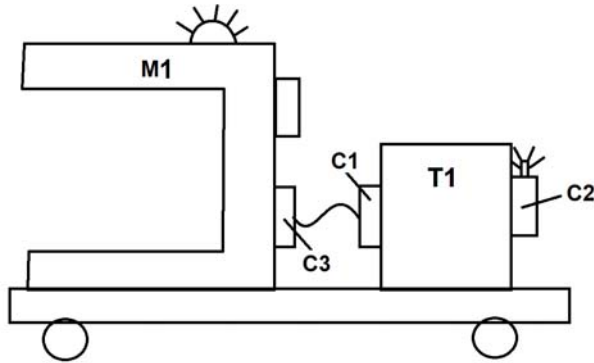

Fig.3. The system layout and connection scheme of the thermostat.

The comprehensive temperature control (T1) and thickness measurer (M1) are independent systems that are connected through the coolant circuit. The coolant circuit is closed by flexible hoses through the coupling connectors located in the switchboards (C1) and (C3). The controls and indicators for operating the thermostat are located in the distribution panel (C2).

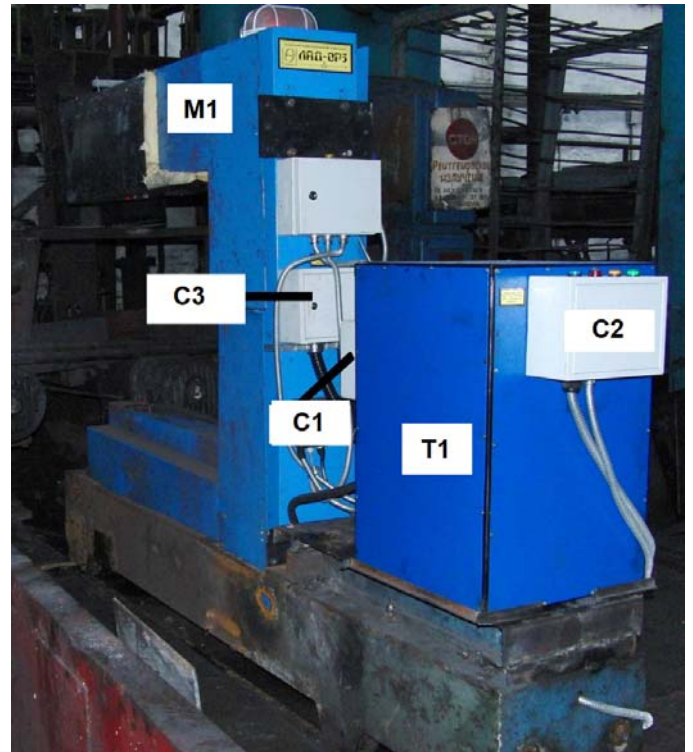

Fig.4. Thermostat in the measuring system.

The comprehensive temperature control is equipped with a heating and cooling module for the circulating coolant. The heat carrier is heated using a dual thermocouple with a total power of 4 kW. Cooling is carried out using an insulated flow-through heat exchanger of cold water, built into the accumulator tank of the comprehensive temperature control system. The hydraulic circuit of the comprehensive temperature control system is shown in fig. 6.

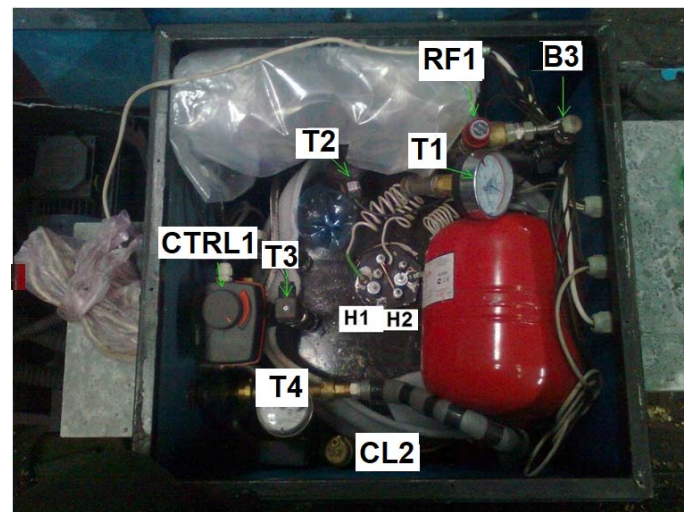

Fig.5. Основные узлы термостата.

The comprehensive temperature control system operating modes are controlled using a programmable controller located inside the system box. The following comprehensive temperature control system components are connected to the controller: circulation pump (P1), flow switch (RF1), coolant temperature sensor (T2), flow cold water temperature sensor (T3), cold water flow controller (CTRL1), electric heaters (H1) and (H2).

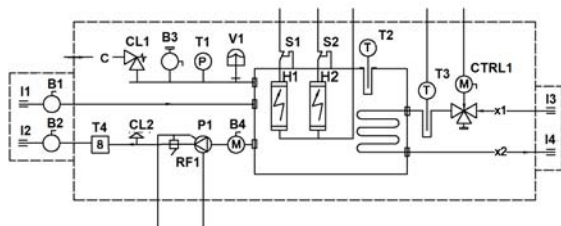

Fig.6. Hydraulic circuit of the thermostat.

The circulation pump (P1) maintains constant circulation of the coolant. The pump has an integrated flow switch (RF1) to protect against improper operation.

Heating of the heat carrier is carried out using electric heaters (H1) and (H2), the chains of which are connected through protective temperature switches. The protective switches (S1) and (S2) are designed for emergency shutdown of heaters when the case of the storage tank overheats above 80°C.

The coolant is cooled by cold water flow with rate regulated by an electronically controller (CTRL1). The cold water circuit is connected via connections (I3) and (I4) located in the switchboard (C1).

The expansion tank (V1) and the safety valve (CL1) provide compensation and protection during temperature expansion of the coolant and storage tank. A pressure gauge (T1) is used to control overpressure. The storage tank is replenished through the inlet of the stopcock (B3). Visual adjustment of the filling level, according to the liquid column in the tap channel (B3). Shut-off valves (B1), (B2), (B4) are normally open, the closed state is used when servicing the temperature control system. The valve (B3) is normally closed; the open state is used when servicing the comprehensive temperature control system.

The thermostat controller provides reliable continuous operation of the measuring system. The passive part of the thermostabilizing subsystem reduces and smoothes out the peak temperature effects on the measuring system, both by abrupt

heating (during measurement of the thickness of hot metal, which has a temperature up to 1000 degrees and is in close proximity to the measuring system), and during cooling (when opening gate to the workshop in winter time). The test results in the conditions of the metallurgical workshop demonstrate the operability and reliability of the applied methods of comprehensive temperature control.

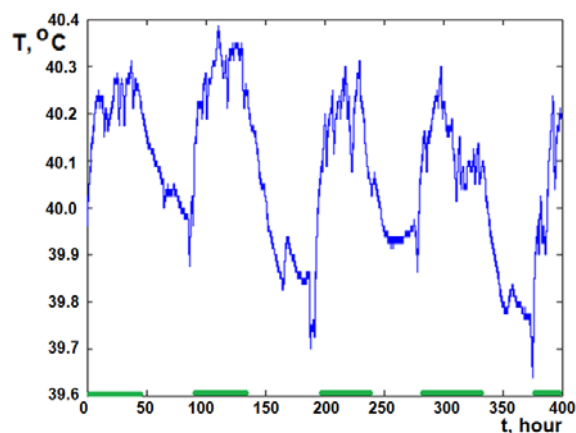

Fig7. Dynamics of the temperature of the measuring system at the rolling mill in the hot rolling workshop for 16 days (green line indicate the time of the shop work).

Fig. 7 presents the results of testing the thermal stabilization subsystem in the hot-rolled shop for 16 days. It has been established that the thermal stabilization subsystem provides the temperature stability of the optical modules of the measuring system at the level of 0.5 degrees.

4 Conclusion

The developed and implemented comprehensive temperature control provides stabilization of the temperature of optical measuring modules of thickness measurement system of hot metal rolling at the level of 0.5 degrees. Such thermal stabilization made it possible to ensure high accuracy in measuring the thickness of hot metal rolling in a hot metallurgical production workshop.

The developed comprehensive temperature control as part of system for measuring the thickness of hot metal rolling successfully operates in a hot metallurgical workshop at the Novosibirsk Metallurgical Plant named Kuzmina and provides an error in measuring the thickness of hot metal rolling

at a level of 10^{-5} from the measuring base.

The theoretical part of the work was supported by state state contract of the IT SB RAS. The development and implementation of the hydraulic part of the theperature control system was supported by grant MD 1767.2020.8. The thermostat control module was developed with support of Russian Fund of Fundamental Researches (project 18-08-00910).

References:

- [1] Dvoynishnikov S.V., Meledin V.G. Optoelectronic Differential Cloudy Triangulation Method for Measuring Geometry of Hot Moving Objects / Optoelectronics in Machine Vision-Based Theories and Applications, M.Rivas-Lopez, O.Sergiyenko, W.Flores-Fuentes, J. C. Rodríguez-Quiñonez, August 2018, p. 49-78.
- [2] Dvoynishnikov S.V., Meledin V.G. Laser Differential Cloudy Triangulation with Video Flow Synchronization // IEEE International Symposium on Industrial Electronics, June 2019, №8781343, Pp. 1700-1705.
- [3] Dvoynishnikov S.V., Kabardin I.K., Meledin V.G. (2020) Advanced Phase Triangulation Methods for 3D Shape Measurements in Scientific and Industrial Applications. In: Sergiyenko O., Flores-Fuentes W., Mercorelli P. (eds) Machine Vision and Navigation. Springer, Cham.
- [4] Dzhashitov V.E., Pankratov V.M. On the possibility of control of interconnected mechanical and thermal processes in nonlinear temperature-perturbed dynamic systems // Journal of Computer and Systems Sciences International, 2009, V.48, № 3. – P. 481-488.
- [5] Dzhashitov V.E., Pankratov V.M. Control by the interconnected mechanical and thermal processes of nonlinear dynamic systems with feedback to thermal perturbation // 14th Saint-Petersburg International Conference on Integrated Navigation Systems, ICINS 2007. - P. 84-87.
- [6] Dzhashitov V.E., Pankratov V.M. Elastic Suspension of a Superminiature MEMS Gyro // Gyroscopy and Navigation. 2011. V. 2. № 4. - P. 239-246.
- [7] Barbour N., Madden P., Socha M. Development of a micromechanical gyro package with GPS for small pointing Satellites //Gyroscopy and Navigation - 1996.-№ 2(13).- C.7-15.
- [8] Dzhashitov V.E., Pankratov V.M., Efremov M.V., Romanov A.V. An Active Thermal Control System on Peltier Modules for a Strapdown IMU-Based on Fog for Space and Ground Applications // 21st Saint Petersburg International Conference on Integrated Navigation Systems, ICINS 2014 – P. 319-322.
- [9] Dzhashitov V.E., Pankratov V.M. Using the Method of Elementary Balances for Analysis and Synthesis of Thermal Control System for Fog Sins Based on Peltier Modules // Gyroscopy and Navigation. 2014. V. 5. № 4. - P. 245-256.
- [10] Dzhashitov V.E., Pankratov V.M. Deterministic Chaos in Disturbed by Temperature Fiber-Optical Inertial Sensors // Progress in Biomedical Optics and Imaging. 1998. V. 3726.- P. 101.
- [11] Dvoynishnikov S., Rakhmanov V. Power installations geometrical parameters optical control method steady against thermal indignations // EPJ Web of Conferences, № 82, 2015. pp. 01035-3.
- [12] Dvoynishnikov S., Meledin V., Bakakin G., Kulikov D. Laser Cloudy Triangulation Method for Geometrical Measurements Under the Optical Refraction Conditions / 2015 International Conference on Computer Science and Environmental Engineering, May 17-18, 2015, Beijing, China (CSEE2015) - p.532-538.
- [13] Koshekov K.T., Klikushin Y.N., Gladkov M.V., Dvoynishnikov S.V., Koshekov A.K. Assessment of thickness effective value of hot-rolled steel sheets on the basis of the identification measurements // 2nd International Conference on Advances in Computing, Communication, & Automation (ICACCA), Dehradun (India), 15-16 September, 2016
- [14] Schubert T., Ernest M. K. Fundamentals of Electronics: Book 1 Electronic Devices and Circuit Applications // Fundamentals of Electronics: Book 1 (2015).
- [15] Patnaik, L.M., Viswanadham, N., Sarma, I.G. Computer Control Algorithms for a Tubular Ammonia Reactor // (1980) IEEE Transactions on Automatic Control, 25 (4), pp. 642-651.
- [16] Terrand-Jeanne, A., Andrieu, V., Tayakout-Fayolle, M., Dos Santos Martins, V. Regulation of Inhomogeneous Drilling Model with a P-I Controller // (2020) IEEE Transactions on Automatic Control, 65 (1), pp. 58-71.