

An Improved Cross Entropy Method for Energy Route Multi-objective Optimization of Wireless Power Transfer Network

YUN SUN^{1,2}, LIJUAN XIANG², XIN DAI²

State Key Laboratory of Power Transmission Equipment & System Security and New Technology¹,
College of Automation²
Chongqing University
CHINA

syue06@cqu.edu.cn, xiang_lijuan@163.com, toybear@vip.sina.com

Abstract: - Recent studies have shown that using relay resonators have the potential to extend the wireless power transmission distance and range. However, the relay resonators can only provide the relay power opportunities from source to relative long destination node without sacrificing too much efficiency, and the space utilization rate is low. To provide steady, high and real-time wireless power charging to any electrical device in a local area, in this paper, novel WPTN pattern called wireless power transfer network is proposed to this problem. In energy route design of WPTN, it is desired to achieve a maximum power transfer efficiency that provides higher output power for the load when maximizing the network reliability. This paper first introduces the basic idea of WPTN and network energy routes design. Then an improved Cross Entropy (CE) method using non-dominated sorting is proposed to solve the multi-objective energy routes problem in WPTN system. Finally, simulation results have demonstrated the effectiveness of the proposed method based on three case studies of 30-node WPTN system.

Key-Words: - Wireless power transfer, Power transfer efficiency, Wireless power transfer network, Multi-objective optimization, Routing problem, CE method, Non-domination sorting.

1 Introduction

Wireless power transfer has been proposed for many years and widely used in various applications successfully. Most are “short range”, the reason for its not being widely used in relatively long range is mainly due to the exponentially decreasing power transfer efficiency with the transmission distance. In recent years, vast research and literature has grown up relating to improve the power transfer efficiency. Typical strategies employed can be classified into two categories. First strategy involves the conventional solutions to maximize power transfer efficiency in WPT system, such as compensation topologies, parameters optimization techniques [1-4]. Although these solutions are effective in some extent, transmission distance is still limited by the power transfer efficiency. In addition, intermediate relay resonators which receive the power from the primary coil then transfer it to the secondary coil is proposed to prolong the transmission distance. Different from the conventional strategies, relay resonators technique makes it possible for WPT to its applications to mid-range [5-7]. However, the relay resonators is placed between two coils only to relay the power. For realizing wireless power transfer to swarm electronic devices based on

different demands, those typical strategies. To solve this problem, a novel pattern of WPT, wireless power transfer network (WPTN) is now considered as a promising approach with the potential to broaden the applications of WPT technology and improve the transmission range. Electronic devices comprise the network, and each device can be seen as power node. WPTN can extend the transmission distance without satisfying too much power transfer efficiency, while power from a source node to a far destination node is transferred via some other nodes.

The rest of this paper is organized as follows. Section 2 presents the details of WPTN. The energy route design of WPTN is discussed in Section 3, basic idea of routing and routing problem are stated, then multi-objective routing model is proposed in detail. Section 4 presents the details of the improved CE method using non-dominated sorting for solving the optimizing routing problem. Simulations and results are discussed in Section 5. Finally, conclusions are given in Section 6.

2 Wireless power transfer network

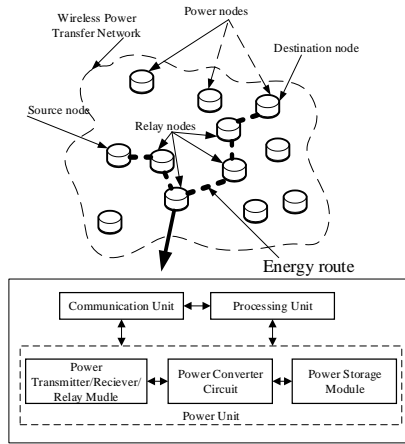
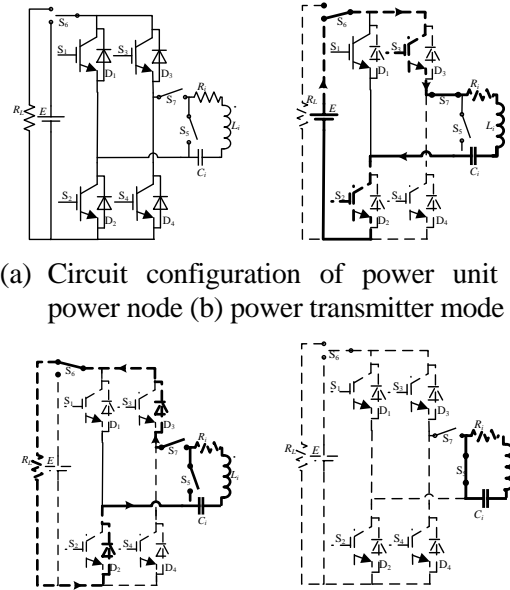

Fig.1 WPTN and basic components of a power node

Each electronic device is seen as power node and usually scattered in the network, which as shown in Fig. 1. Power are transferred from the source node to destination node by a multi-hop relay nodes. Each of power nodes has the capacities to transfer, receive or relay the power. A power node is made up of three components, as shown in Fig. 1: a power unit, a communication unit and a processing unit. The communication unit connects other nodes in the network. The processing unit manages the messages from the communication unit that makes the power node collaborate with other nodes to carry out the power transfer mission. One of the most important components of a power node is the power unit. Power units are usually composed of three subunits: power transmitter/receiver/relay module, power converter circuit and power storage module.

Fig. 2 shows the circuit configuration and three modes of the power unit. As seen in (a), the power unit of a power node is composed of load R_L , battery E , two switch pairs(S_1, S_4) and(S_2, S_3) and inverse parallel diodes(D_1 - D_4), the inductor of coil L_i , resonant capacitor C_i and equivalent resistance R_i . Three switches S_5 - S_7 are used to switch the different three modes. (b) shows power node is in power transmitter mode when the position of S_6 is down, S_5 is OFF state and S_7 is ON state, the two switch pairs operates complementarily and transfer the DC current input from the battery E to high frequency current and produce alternating magnetic field through LC resonant network. (c) shows power node picks up the power from the alternating magnetic field through LC resonant network and transfer the power to DC output to the load R_L . Power node relays the power when S_6, S_7 are OFF state and S_5 is ON state shown in (d), which only comprises LC resonant network.



(a) Circuit configuration of power unit of a power node (b) power transmitter mode

(c) power receiver mode (d) power relay mode

Fig.2 Circuit configuration and modes explanation of the power unit of a power node

3 Routing in WPTN

3.1 Basic idea of energy route in WPTN

Assuming the overall equivalent circuit configuration of an energy route with $n+2$ nodes as showing in Fig. 3, which has n relay nodes, the mathematical model using circuit theory can be derived as equation (1):

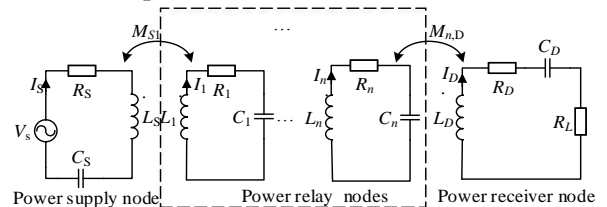

Fig.3 Mathematical model of energy route

where I_s is the AC excitation source; ω_i is the angular frequency of v_i node, assuming that all nodes have the same frequency $\omega_i=2\pi f_i$; assuming the effects of the magnetic coupling of nonadjacent nodes can be neglected, $M_{i,i+1}$ is mutual inductance between v_i and v_{i+1} node and can be calculated from:

$$M = \rho \times \sum_{i=1}^{i=n_p} \sum_{j=1}^{j=n_s} M_{ij} \text{ and}$$

$$M_{ij} = \frac{\mu_0 \pi a_i^2 b_j^2}{2(a_i^2 + b_j^2 + z^2 + x^2)^{3/2}} \times \left[1 - \frac{3}{2} \delta_{ij} + \frac{15}{32} \gamma_{ij}^2 \left(1 - \frac{21}{2} \delta_{ij} \right) + \frac{15}{16} (\alpha_{ij}^2 + \beta_{ij}^2) \left(1 - \frac{7}{4} \delta_{ij} \right) \right]$$

where parameter ρ depends on the shape of the coil, n_p and n_s are the number of turns for the former and

$$\begin{bmatrix} R_S + j(\omega L_S - \frac{1}{\omega C_S}) & j\omega M_{S1} & \cdots & j\omega M_{Sn} & j\omega M_{SD} \\ j\omega M_{S1} & R_1 + j(\omega L_1 - \frac{1}{\omega C_1}) & \cdots & j\omega M_{1n} & j\omega M_{1D} \\ \vdots & \vdots & \ddots & \vdots & \vdots \\ j\omega M_{Sn} & j\omega M_{1n} & \cdots & R_n + j(\omega L_n - \frac{1}{\omega C_n}) & j\omega M_{nD} \\ j\omega M_{SD} & j\omega M_{1D} & \cdots & j\omega M_{nD} & R_D + j(\omega L_D - \frac{1}{\omega C_D}) + R_L \end{bmatrix} \begin{bmatrix} I_S \\ I_1 \\ \vdots \\ I_n \\ I_D \end{bmatrix} = \begin{bmatrix} V_S \\ 0 \\ \vdots \\ 0 \\ 0 \end{bmatrix} \quad (1)$$

later coil, a and b are the radius of coils, x is the lateral displacement symmetry, z is the distance between two concentric coils. And

$$\delta_{ij} = \frac{x^2}{a_i^2 + b_j^2 + z^2 + x^2}, \gamma_{ij} = \frac{2a_i b_j}{a_i^2 + b_j^2 + z^2 + x^2},$$

$$\alpha_{ij} = \frac{2x a_i}{a_i^2 + b_j^2 + z^2 + x^2}, \beta_{ij} = \frac{2x b_j}{a_i^2 + b_j^2 + z^2 + x^2}$$

All three units of node exist energy consumption, although communication (including data transmission and data reception) among nodes and processing unit consume energy, they can be ignored while comparing to the main unit, power unit. The main power loss in power unit is the loss in coil. The energy consumption of node i can be defined as:

$$P_{v_i_loss} = I_{v_i}^2 R_i \quad (2)$$

where I_{v_i} is the current and R_i is the equivalent resistance of the coil, the current I_{v_i} can be derived from equation.

3.2 Energy route problem statement

The WPTN network is denoted as a graph $G=<V, E, R>$, where V denotes the set of power nodes and E denotes the set of power transfer links, which can be expressed respectively as $V=\{v_1, v_2, v_{n-1}, v_n\}$ and $E=\{(v_i, v_j), i \neq j, v_i, v_j \in V\}$, R denotes the set of energy routes, which is a set of nodes and links, where the subscript refers to the sequence of each node, especially, subscript s refers to source node and d refers to destination node.

For any node v_i and v_j , where $v_i, v_j \in V$, each node allows bi-directional wireless power transmission, $x_{v_i v_j}$ can be 0 or 1, which means the power transfer link between node v_i and v_j has two states:

- (1) $x_{v_i v_j}=0$, which means link (v_i, v_j) does not belong to the energy route,
- (2) $x_{v_i v_j}=1$, which means link (v_i, v_j) belongs to the energy route.

If there exists a link $(v_i, v_j) \in E$ while $x_{v_i v_j}=1$, the power is transferred from node v_i to v_j . For any node v_i , it has limited effective power transmission range

D_{max} , nodes are connected when the distance between them are smaller than limited effective power transmission range ($D \leq D_{max}$). And nodes can switch three different modes according to wireless power transfer mission. Based on the mission, power nodes can be classified as source node, relay nodes and destination node. Route denotes the orderly sequence of links, which means the power is transferred from source node to destination node through some relay nodes.

3.3 Multi-objective energy route model

The aim of the optimal energy route problem of the WPTN system is to select the optimal energy route with objective functions, subject to associated constraints. In the present work, it is assumed that the location of each node are known and there is only one source node and one destination node. Each node are stationary, and there are no directed cyclic links in any energy route. Thus, the main objectives of the energy route problem in this paper has two components. One is to maximize the power transfer efficiency while transferring the power, and the other is to maximize the liability of the whole network. The objectives and their constraints are described below in detail.

WPTN is a specific network which focus on the quality of the power transmission. In this paper, the following mathematical formulation is suggested to find multi-objective optimal energy route in this network, namely

$$f_1 = \frac{P_{in} - \sum_{v_i \in V} \sum_{v_j \in V} h_{v_i v_j} P_{v_i_loss}}{P_{in}} \quad (3)$$

$$f_2 = \sum_{\forall v_i} k_{v_i} P_{v_i_load} \quad (4)$$

$$f_3 = \min(I_i) \quad (5)$$

subject to:

$$\sum_{v_i \in V} x_{v_i v_j} = 1, \forall v_j \in V / \{v_s\} \quad (6)$$

$$\sum_{v_j \in V} x_{v_i v_j} = 1, \forall v_i \in V / \{v_d\} \quad (7)$$

$$P_{load} = I_{v_d}^2 R_L \geq P_0 \quad (8)$$

$$U_{load} = I_{v_d} R_L \leq U_0 \tag{9}$$

$$I_{v_i} \leq I_{max}, \forall v_i \in V \tag{10}$$

$$U_{v_i} \leq U_{max}, \forall v_i \in V \tag{11}$$

$$M_{min} \leq M_{v_i v_{i+1}} \leq M_{max}, \forall v_i \in V / \{v_s\} \tag{12}$$

$$L_{v_i v_{i+1}} = \sqrt{(x_{v_i} - x_{v_{i+1}})^2 + (y_{v_i} - y_{v_{i+1}})^2} \leq L_{max}, \forall v_i \in V / \{v_s\} \tag{13}$$

where if node v_i is covered $h_{v_i}=1$, 0 otherwise, if the load of node v_i needs the power $k_{v_i}=1$, 0 otherwise, I_0 is current threshold, I_{v_i} is current of node v_i , U_0 is voltage threshold, U_{v_i} is voltage of node v_i , I_{max} and U_{max} are the upper limit of current and voltage, P_0 is the power lower limit of the load.

The objective function (3) is to be maximized for the power transfer efficiency when the power is transferred to a destination node. The output power is maximized by maximizing the objective function (4). The third objective function f_3 is to be maximized the network reliability. Constraint (6) and (7) indicate that the each node is covered in energy route at most once. Constraint (8) states power demand for the load, to a same equivalent source current, the power which the energy route can transfer should not less than the power demand. According the constraint (9-13), different energy routes from a source node to destination node are judged whether it has the ability to complete power transfer mission or not.

Functions (3-13) are the NLP (Nonlinear Problem) model of routes design in WPTN system, evolutionary algorithms are the common method for solving this problem. The CE method, which is based on the information theory and entropy, can give an optimal solution to optimization problem. Thus, an improved CE method is proposed and discussed in detail in next section.

4 Optimization using improved CE method

4.1 CE method

The CE method was motivated by Rubinstein as an adaptive algorithm for estimating probabilities of rare events in stochastic network in 1997, which has been broadened as an heuristic algorithm and widely used in solving NP-hard problems in various applications [8-10]. In this Section, the CE method for combinatorial optimization is briefly outlined, for detail in the CE website and Annals of Operations Research in 2005.

Consider the following maximization problem, where χ is the space, let f be a family of probability density functions on χ . The probability can be expressed as:

$$l(\gamma) = P_{\mu}(f(x) \geq \gamma) E_{\mu} I_{\{S(x) \geq \gamma\}} \tag{14}$$

It can be estimated directly by using Crude Monte Carlo method, however, $f(x) \geq \gamma$ is called a rare event when l is very small, importance sampling is introduced to improve performance of the simulation. Using another probability density, it can be rewritten as:

$$l = \int I_{\{S(x) \geq \gamma\}} \frac{f(x; \mu)}{g(x)} g(x) dx = E_g I_{\{S(x) \geq \gamma\}} \frac{f(X; \mu)}{g(X)} \tag{15}$$

The best way to estimate l is to use the change of the measure with density g :

$$g^*(x) := \frac{I_{\{S(x) \geq \gamma\}} f(x; \mu)}{l} \tag{16}$$

And then a measure of distance between two densities g and h called Kullback-Leibler distance can be defined as:

$$D(g, h) = E_g \ln \frac{g(X)}{h(X)} = \int g(x) \ln g(x) dx - \int g(x) \ln h(x) dx \tag{17}$$

The minimization of the Kullback-Leibler distance can be achieved by maximizing:

$$\begin{aligned} \max_v D(v) &= \max_v \int g^*(x) \ln f(x; v) dx \\ &= \max_v \int \frac{I_{\{S(x) \geq \gamma\}} f(x; \mu)}{l} \ln f(x; v) dx \end{aligned} \tag{18}$$

Then the optimal solution and estimation can be expressed as follows:

$$v^* = \operatorname{argmax}_v E_{\mu} I_{\{S(x) \geq \gamma\}} \ln f(x; v) \tag{19}$$

$$\hat{v}^* = \operatorname{argmax}_v \frac{1}{N} \sum_{i=1}^N I_{\{S(x) \geq \gamma\}} \ln f(x_i; v) \tag{20}$$

The CE method is a multi-level algorithm and the two main procedure is as follows:

- (1) Adaptive updating of γ_t . For a fixed v_{t-1} , let γ_t be the $(1-\rho)$ -quantile of $f(x)$ under v_{t-1} .
- (2) Adaptive updating of v_t . For fixed γ_t and v_{t-1} , v_t can be derived by solving the maximization problem of the Kullback-Leibler distance $D(v)$.

4.2 Non-dominated Sorting

Optimal energy route problem is a multi-objective optimization and NP-hard problem. Generally, preference parameters are introduced to convert multi-objective optimization problem into single-objective optimization problem. However, it is unreliable and hard to choose the parameters in practice. Meanwhile, the objectives often conflict with others. Improvement of one objective may lead to the deterioration of the others. The best and optimal solution may not be attainable unless the search space is convex, because it is nearly impossible that any solution can optimize all the objectives simultaneously. Pareto front is introduced to optimizing multi-objective problem [11-14], which

is a set of acceptable trade-off optimal solutions. A sorting criterion for selecting the elite examples in the population based on non-dominated sorting is proposed in CE method. For a multi-objective minimization optimization problem with M objectives, which can be expressed as Minimize $F(x) = \{f_1(x), f_2(x), \dots, f_m(x)\}$, where solution $x \in X$, X denotes the feasible search space.

Definition 1: A solution x_1 dominates x_2 if and only if

$$\forall i \in \{1, 2, \dots, m\}, f_i(x_1) \leq f_i(x_2) \wedge$$

$$\exists j \in \{1, 2, \dots, m\}, f_j(x_1) < f_j(x_2)$$

Definition 2: For $S = \{x_i, i=1, 2, \dots, n\}$, solution x denotes a non-dominated solution (Pareto solution) of set S if $x \in S$, and there is no solution $y \in S$ for which y dominates x .

Definition 3: Set S is a Pareto front which contains all the dominated solutions.

4.3 Improved CE method for multi-objective energy route problem

Energy routes problem of WPTN system is a multi-objective problem that involves objectives such as output power of the destination node, power transfer efficiency of energy route and network reliability.

CE method is a global random search algorithm, which also enjoys asymptotic convergence properties and simple adaptive procedure. In order to improve the multi-objective optimization property of the CE method, some modifications are considered in this paper. The general framework and basic concepts of the CE method and non-domination sorting were detailed described in the above, in this subsection, those components of the improved CE method specifically designed to solve multi-objective energy route problem of WPTN. The purpose of this approach is to introduce such a novel method, and provide a new, effective method to energy route design.

The flow chart of the algorithm is shown in Fig. 4. The main procedure of the proposed method is given in the following:

(1) Initially, input all the CE and WPTN parameters.

(2) Generation, generate each reasonable solution and calculate all the objective values f_1 , f_2 and f_3 respectively using the NLP model.

(3) Combine the contemporary population and superior solution to new population using non-domination sorting strategy.

(4) Update the population generation

probability, in case to jump out of the local optimal solutions.

(5) Get the final solution set.

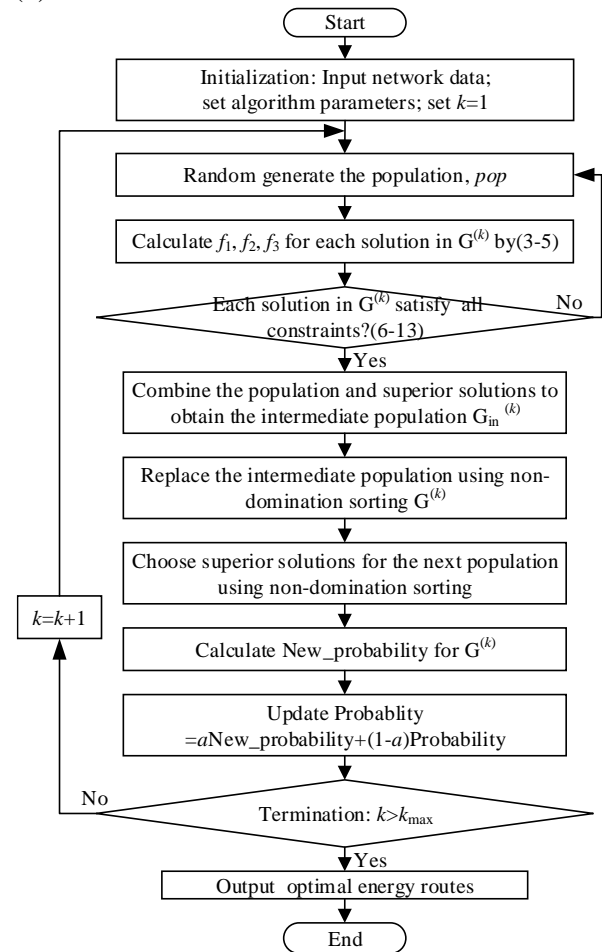

Fig.4 Flow chart of improved CE method for multi-objective energy route problem

5 Numerical example and simulation results

To demonstrate the applicability and effectiveness of the proposed method, a 30-node WPTN system in $1m \times 1m$ area is taken, shown in Fig. 5. Each node is numbered. Assume the node 1 is the source node and node 30 is the destination node. The proposed method was coded in MATLAB software and all simulation were conducted on a computer.

The parameters of improved CE method and their stop criteria are se as followings: Population size(pop)=200, Maximum of generations(k_{max})=1000, Smooth parameter(a)=0.7. Parameters of WPTN are listd in Table 1. Totally three case are studied.

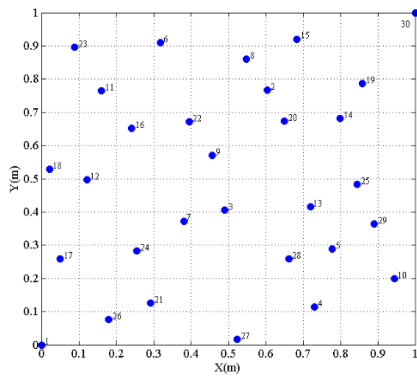

Fig.5 30-node WPTN

Case 1: To obtain a maximum power transfer efficiency, only objective f_1 is considered. To obtain a highest power capacity, only output power of the destination node (objective f_2) is considered.

Case 2: Combining f_1 and f_2 to obtain a two-objective optimization problem, both power transfer efficiency and output power are considered.

Case 3: To obtain a maximum network reliability and power transfer ability, objective f_1, f_2, f_3 are considered.

To verify the fast convergence and global search of the crude CE method, f_1 and f_2 are optimized respectively, the dynamic convergences are shown in Fig.6 and Fig.7. For single optimization problem, the crude CE method converges within 10-20 iterations and skips the local optimum and achieves the global maximum, which possesses the ability to optimize speedily and works out problems without the limit of the partial optimum. The maximum value of f_1 , power transfer efficiency is 89.43%, and the optimal solution is (1,26,17,7,22,15,30), then calculate the output power using equation (4), $f_2=37.94$ W. The maximum value of f_2 , output power of the node 30 is 551.18 W, and the optimal solution is (1,26,22,15,30) while $f_1=47.37\%$. Fig.8 shows the profiles of current magnitudes in case 1. The currents are higher when maximize the objective f_2 compared to maximizing f_1 .

Table 1

30-node WPTN Parameters

Number of nodes(N)	30
Frequency(f)	100 kHz
Current of source node(I_s)	1 A
Equivalent resistance of coil(R_i)	0.05 Ω
Inductance of coil (L_i)	147.9 μ H
Resistance of load	10 Ω
P_0	30 W
U_0	95 V
I_{max}	150 A
U_{max}	14000V
M_{min}	6.8 μ H
M_{max}	0.05 μ H
L_{max}	0.3 m

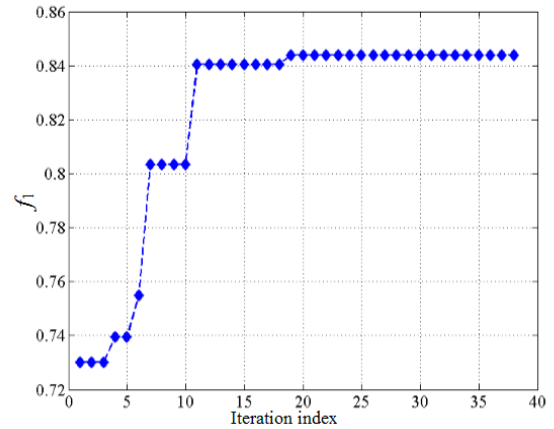

Fig.6 Convergence plot for the crude CE method for maximize f_1

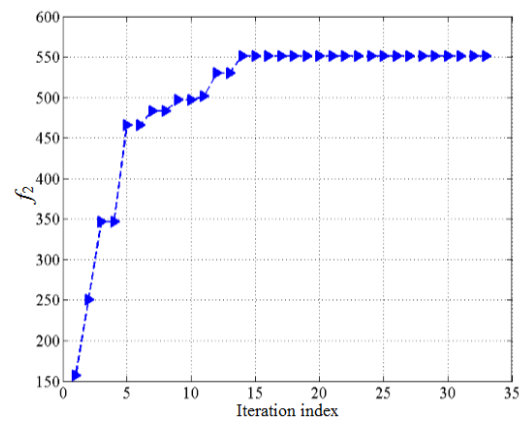

Fig.7 Convergence plot for the crude CE method for maximize f_2

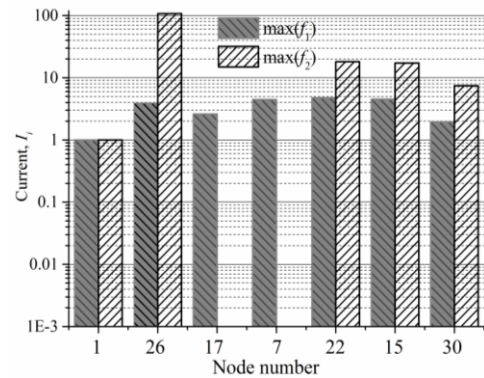

Fig.8 Node current profiles of max (f_1) and max (f_2)

Turn to Case 2, to verify the effectiveness of the proposed method (in Fig.4), it focuses both on the power transfer efficiency and output power level, because in different applications, the objective and final goal seems to be different. In this case, Fig. 9 is the Pareto front (rank=1) after 30 iterations, it shows that the improved CE method has a better performance, various diversity, good continuous and uniformity, besides, the success ratio after 30 iterations is 96.7%, this case also indicate the improved CE method is a practical tool for solving

two-objective problem. Fig. 10 are the solution sets of different ranks in 15 iteration, the blue one represent the Pareto front in this iteration and finally converges to the Fig. 9 .

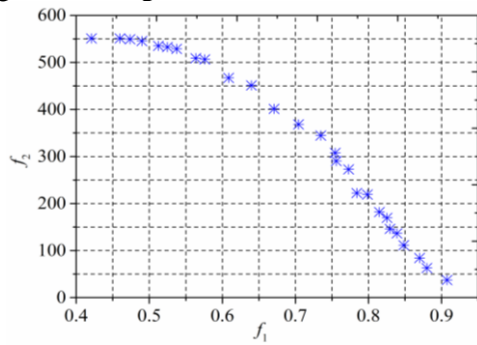

Fig.9 Pareto front obtained by the proposed improved CE method after 30 iterations

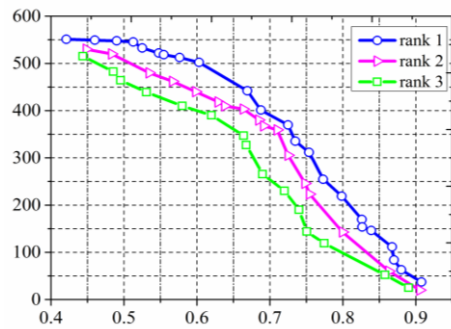

Fig.10 Different ranks (rank=1, 2, 3) in 15 iteration

Fig. 11 demonstrates the Pareto front at different I_1 values, when the current of the source node increases from 1 A to 2 A. It can be observed that, to a specific WPTN system, objective f_1 , the power transfer efficiency is immune to the source node current increase of the system, the power transfer efficiency of which all changes from 40% to 90%. On the other hand, the output power level changes rapidly, the maximum f_2 is nearly 500 W when $I_1=1$ A, the blue and red one is approximate 1.25 kW and 2.25 kW respectively.

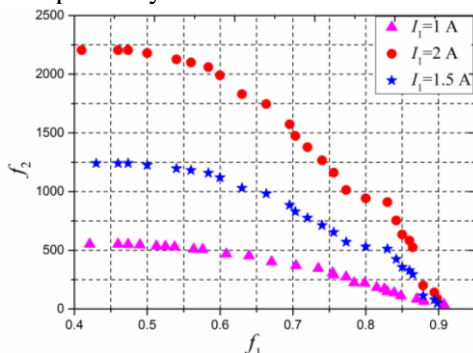
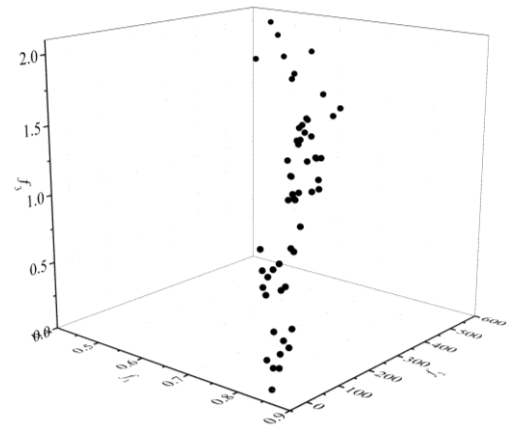

Fig.11 Pareto fronts for two-objective optimization at different I_1

Case 3 takes both the network reliability and power transfer ability, three objectives are considered. The final global Pareto front for multi-

objective (f_1, f_2, f_3) is shown in Fig.12. The Pareto front comprises a curved surface, the mutual inductance among those nodes in WPTN are discontinuous, which the Pareto solution is scattered among the feasible solutions, specifically, the difference of the energy routes design, the values of three objectives are changing unpredictable.



(a) view 1

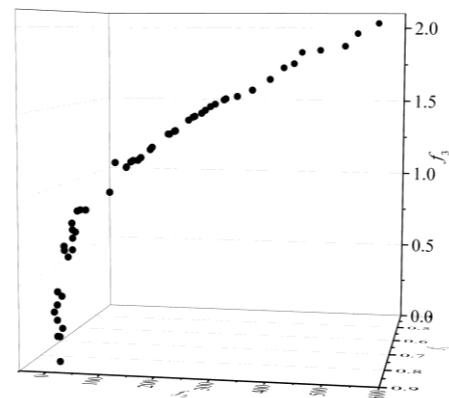

(b) view 2

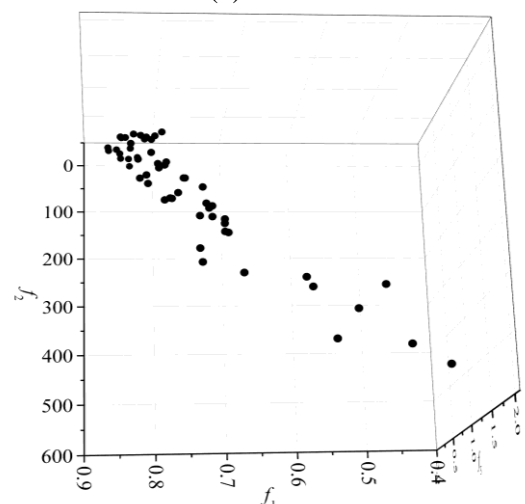

(c) view 3

Fig.12 Pareto front for multi-objective optimization after 40 iterations (view 1-3)

6 Conclusions

Rapid applications of WPT technology, the WPTN seems a novel pattern. Optimal energy routes designing must realize the wireless power transmission in a network by offering high network reliability while maximizing the power transfer efficiency and output power. To this end, a new multi-objective energy routes designing model has been developed in this paper to address the various concerns from both the power transfer ability and network reliability. An improved CE method has been employed to solve the multi-objective problem because its simplicity, efficiency and fast asymptotic convergence properties. Based on the proposed method, the optimal solution for f_1, f_2 , the Pareto front for (f_1, f_2) and (f_1, f_2, f_3) can be achieved. The case studies indicate that the proposed method solve the multi-objective optimization for energy routes design successfully.

7 Acknowledgements

This work was supported in part by the National Natural Science Foundation of China (No.51277192, 51377183), the Visiting Scholarship of State Key Laboratory of Power Transmission Equipment & System Security and New Technology (Chongqing University) (No. 2007DA105127XXXXX). The authors would like to thank Dr. Chao Hu for simulation support to this work. The authors would like to thank all reviewers for their valuable comments.

References:

- [1] Jamal N., Saat S., Yusmatnita Y., A development of Class e converter circuit for loosely coupled inductive Power Transfer system, *WSEAS Transactions on Circuit and Systems*, Vol.13, No.1, 2014, pp. 422-428.
- [2] Dai X. Sun Y., An Accurate Frequency Tracking Method Based on Short Current Detection for Inductive Power Transfer System, *IEEE Transactions on Industrial Electronics*, Vol.61, No.2, 2014, pp. 776-783.
- [3] Chaari M. Z., Ghariani H., Lahiani M., Design and construction of a system for wireless charging the battery of a robot, *WSEAS Transactions on Power Systems*, Vol.10, No.1, 2015, pp. 27-34.
- [4] Dai X, Zou Y., Sun Y., Uncertainty Modelling and Robust Control for LCL Resonant Inductive Power Transfer System, *Journal of Power Electronics*, Vol.13, No.5, 2013, pp. 814-823.
- [5] Hui S.Y.R., Zhong W.X., Lee C.K., A critical Review of Recent Progress in Mid-Range Wireless Power Transfer, *IEEE Transactions on Power Electronics*, Vol.29, No.9, 2014, pp. 4500-4511.
- [6] RamRakhyani A.K., Lazzi G., On the Design of Effective Multi-Coil Telemetry System for Biomedical Implants, *IEEE Transactions on Biomedical Circuits and Systems*, Vol.7, No.1, 2013, pp. 11-23.
- [7] Mori K., Hyunkeun L., Iguchi S., Ishida K., Takamiya M., Positioning-Free Resonant Wireless Power Transmission sheet with Staggered Repeater Coil Array, *IEEE Antennas and Wireless Propagation Letters*, Vol.11, 2012, pp. 1710-1713.
- [8] De B. PT., Kroese DP., Mannor S., A tutorial on the Cross-Entropy Method, *Annals of Operations Research*, Vol.134, 2005, pp. 19-61.
- [9] Naaem M., Khwaja A.S., Anpalagan A., Jaseemuddin M., Green Cooperative Cognitive Radio: A Multiobjective Optimization Paradigm, *IEEE SYSTEM JOURNAL*, Vol.PP, No.99, 2014, pp. 1-11.
- [10] Wang G., Xu Z., Wen F., Wong K., Traffic-Constrained Multiobjective Planning of Electric-Vehicle Charging Stations, *IEEE Transactions on Power Delivery*, Vol.28, No.4, 2013, pp. 2363-2372.
- [11] Jeyalakshmi V., Subburaj P., Load frequency control in two area multi units Interconnected Power System using Multi objective Genetic Algorithm, *WSEAS Transactions on Power Systems*, Vol.10, No.1, 2015, pp. 35-45.
- [12] Fang H., An effective Non-dominated Sorting Method for Evolutionary Algorithms, *Evolutionary Computation*, Vol.3, No.16, 2008, pp. 355-384.
- [13] Li W.T., Hei Y.Q. Yang J. , Optimisation of non-uniform time-modulated conformal arrays using an improved non-dominated sorting genetic-II algorithm, *IET Microwaves, Antennas & Propagation*, Vol.8, No.4, 2014, pp. 287-294.
- [14] Deb K., Pratap A., Agarwai S., A Fast and Elitist Multiobjective Genetic Algorithm: NSGA- II , *IEEE Transactions on Evolutionary Computation*, Vol.6, No.2, 2002, pp.12-197.