

Matrix Equations in Multivariable Control

ROMAN PROKOP, JIŘÍ KORBEL

Tomas Bata University in Zlín

Nám. T.G.M. 5555, 760 01 Zlín

CZECH REPUBLIC

prokop@fai.utb.cz <http://www.utb.cz/fai>

Abstract: - The contribution is focused on a control design and simulation of multi input output (MIMO) linear continuous-time systems. Suitable and efficient tools for description and controller derivation are algebraic notions as rings, polynomial matrices, and Diophantine equations. The generalized MIMO PI controller design is studied for stable and unstable systems. A unified approach through matrix Diophantine equation can be applied in both cases. All stabilizing feedback controllers are obtained via solutions of a matrix Diophantine equation. The methodology allows defining scalar parameters (one or more) for tuning and influencing of controller parameters. A Matlab-Simulink program implementation was developed for simulation and verification of the studied approach. Illustrative examples show the effectiveness and flexibility of the proposed method for some simple MIMO systems.

Key-Words: - Polynomial matrices, Diophantine equations, Multivariable systems, Stabilization.

1 Introduction

The study of multi input–multi output (MIMO) systems has attracted scientific attention for decades. Analysis and control methods and tools have been developed in many monographs (e.g. [1], [2], [4], [8], [12], [14]) as well as in journal and conference contributions (e.g. [3], [9], [10], [16], [18]) or in program toolboxes, e.g. [17]. Multivariable systems represent an interesting research field also from mathematical point of view. Many notions, methods and tools of single input – output (SISO) systems cannot be simply and trivially generalized into multivariable cases. The main problem relates to the matrix non-commutative multiplication. However, many algebraic notions and tools can be successfully utilized also in the non-commutative case. The main tool for continuous- time systems is the Laplace transform and briefly speaking, multivariable linear continuous- time systems are described and expressed by a set of linear differential equations. So, scalar polynomials describing single input – output linear systems are replaced by polynomial matrices. Algebraic notions and modules remain a suitable and effective tool for analysis and control design of MIMO systems. Transfer functions as a ratio of two polynomials are in MIMO cases considered as matrix fractions and due to non-commutative matrix multiplication the denominator can be in the left or right side of the matrix fraction ([2], [8], [12]) in discrete and continuous-time case. Also, a scalar linear Diophantine equation is

generalized into a matrix one, see e.g. [3], [14], [15]. The contribution is scheduled as follows. The basic notions are mentioned in section II, the system description of MIMO systems is introduced in section III. Section IV deals with matrix Diophantine equations and the next section outlines and summarizes a control design. Some first order examples and derivations are presented in section VI. The proposed methodology brings one or several scalar which can tune and influence the control behavior in an easy way. Simulations are presented in Section VII, the last section concludes the contents of the contribution.

2 Polynomial Matrices

Polynomial matrices are called $l \times m$ matrices where all elements of matrices are polynomials in an indeterminate s . This indeterminate can be considered in linear systems as the Laplace operator and the set of polynomial matrices is $R_{lm}(s)$. If $l = m$, then the set of polynomial matrices constitutes a non-commutative ring. A unit in this ring (an inverse element exists in the ring) is a matrix with real nonzero determinant and all units are called unimodular. Generally, $l \neq m$ set $R_{lm}(s)$ is no more a ring. If $A = BC$ then B is a left divisor of A and A is a right multiple of B , while C is a right divisor of A and A is a left multiple of C . Similarly, greatest common left and right divisors are introduced. Two matrices A, B are left (right) equivalent, if $A = U_1 B$ ($A = B U_2$) with unimodular U_1, U_2 . When $A = U_1 B$

U_2 then A, B are simply called equivalent. Matrices with the same number of columns are left coprime if their all left divisors are unimodular matrices and matrices with the same number of row are right coprime if their all right divisors are unimodular ones.

The known extended (scalar) Euclidean algorithm for can be generalized in multivariable cases. A greatest left common divisor $G_1(s)$ can be calculated for A, B with the same number of row by

$$\begin{aligned} A(s)P_1(s) + B(s)Q_1(s) &= G_1(s), \\ A(s)R_1(s) + B(s)S_1(s) &= 0, \end{aligned} \quad (1)$$

Moreover, $L = AR_1 = -BS_1$ is the least common right multiple of A, B . A greatest right common divisor $G_2(s)$ can be calculated for A, B with the same number of columns by

$$\begin{aligned} P_2(s)A(s) + Q_2(s)B(s) &= G_2(s), \\ R_2(s)A(s) + S_2(s)B(s) &= 0, \end{aligned} \quad (2)$$

Also, $L = R_2A = -S_2B$ is the left common multiple of A, B . Relations (1), (2) are the basic algebraic notions for Diophantine equations, see e.g. [1], [3], [10].

3 System Description

A linear continuous-time multivariable (MIMO) system is described by a set of linear differential equations and then it can be easily expressed by the Laplace transform technique in the form

$$A(s)Y(s) = B(s)U(s), \quad (3)$$

where $A(s), B(s)$ are polynomial matrices in the Laplace transform variable s . For control design, it is useful to characterize MIMO linear time-invariant systems in terms of their transfer function matrices. The generalization of single input-output linear system to MIMO ones is very simple in the state space description

$$\begin{aligned} \dot{x}(t) &= Fx(t) + \Gamma u(t), \\ y(t) &= Hx(t) + Lu(t) \end{aligned} \quad (4)$$

The system with l inputs and m outputs in (4) has the state vector $x(t)$ with values in \mathbb{R}^n and real matrices F, Γ, H, L have dimensions $(nxn), (nxl), (mxn), (mxm)$, respectively. Any decomposition

$$G(s) = H(sI - F)^{-1}\Gamma + L \quad (5)$$

defines a rational system's transfer function matrix. A realization (5) is minimal when the state vector dimension n is as small as it can be and this value is called the MacMillan degree and it represents the order of the system. So, $G(s)$ in (5) is a rational matrix function, it means that all entries are rational functions of s . This matrix function can be then expressed by the left or right matrix fraction

$$G(s) = A(s)^{-1}B(s) = B_R(s)A_R(s)^{-1} \quad (6)$$

where A, B, A_R, B_R are polynomial matrices, more details can be found i.e. in [8]. Note, that both matrices $A(s), A_R(s)$ are squared but not necessarily of the same dimension. In the case of systems with l inputs and m outputs, the left denominator $A(s)$ has dimension $l \times l$, while the right denominator $A_R(s)$ has the dimension $m \times m$. However, both matrices are associates and the characteristic polynomial following from the state-space description (4) is also associates. It means that all roots of the mentioned polynomials are same. It means

$$\det A(s) \sim \det A_R(s) \sim \det(sI - F) \quad (7)$$

where F is the squared system matrix in (4). With relation (3) the notion of stability is closely connected. A linear system is asymptotic (internal stable), if all determinants in (3) are stable, for continuous-time systems it means that all roots lie in the open left half of the complex plane.

4 Matrix Diophantine Equations

Diophantine equations defined in commutative rings are linear equations of the form

$$ax + by = c, \quad (8)$$

where a, b, c are known given entries and x, y are unknown ones in the ring. It is well known (see e.g. [1], [2], [8]) that equation (8) has a solution if and only if the greatest common divisor of a, b divides c , briefly $\gcd(a, b) / c$. Moreover, if x_0, y_0 is a pair of particular solutions of (8), then all x, y given by

$$\begin{aligned} x &= x_0 - b_0 t, \\ y &= y_0 + a_0 t, \end{aligned} \quad (9)$$

where t is an arbitrary element of the ring and $a_0=a/gcd(a,b)$, $b_0=b/gcd(a,b)$. Then, without loss of generality, equation (8) can be supposed with coprime a, b and the solution of (8) exists for any c .

The situation is more complex in non-commutative rings, such is a set of polynomial matrices. Due to the non-commutativity of matrix multiplication, equation (8) is split into three kinds of linear matrix equations over the ring. A natural generalization of this equation is either the equation

$$A_1X + B_1Y = C_1, \tag{10}$$

or the equation

$$XA_2 + YB_2 = C_2, \tag{11}$$

Both equations are called unilateral ones. The last equation is called a bilateral one and it has the form

$$A_3X + YB_3 = C_3, \tag{12}$$

In the case of equation (10), matrices (A_1, B_1, C_1) have the same number of rows, while in equation (11) matrices in the triple (A_2, B_2, C_2) have the same number of columns. The solvability of equations (10) – (12) is studied e.g. in [1], [2], [8]. The results can be briefly formulated in the engineering parlance as follows:

- a) Equation (10) has a solution if and only if the greatest left common divisor of matrices A, B is a left divisor of C .
- b) Equation (11) has a solution if and only if the greatest common right divisor of matrices A, B is a right divisor of C .
- c) Equation (12) has a solution if and only if the matrices

$$\begin{bmatrix} A & 0 \\ 0 & B \end{bmatrix}, \begin{bmatrix} A & C \\ 0 & B \end{bmatrix} \tag{13}$$

are equivalent. This case is out of the interest of this contribution and some details can be found in [2].

If a particular solution of a given linear Diophantine equation exists, there exist a set of all solutions. In the case of (10), (11) the sets of solutions are given

$$X = X_0 - \tilde{B}_1T, Y = Y_0 + \tilde{A}_1T, \tag{14}$$

where X_0, Y_0 are particular solutions of (10) and T is an arbitrary polynomial matrix of the appropriate dimension and

$$A_1\tilde{B}_1 = B_1\tilde{A}_1. \tag{15}$$

Solutions of (11) are

$$X = X_0 - T\tilde{B}_2, Y = Y_0 + T\tilde{A}_2, \tag{16}$$

and again X_0, Y_0 are particular solutions of (11), T is an arbitrary polynomial matrix of the appropriate dimension and

$$\tilde{B}_2A_2 = \tilde{A}_2B_2. \tag{17}$$

Relations (15), (17) are nothing else than the opposite matrix fraction. Suitable and convenient tools for the solution of linear matrix equations are offered by a Polynomial toolbox [17] which contains a set of user friendly Matlab functions for various control system purposes.

As a simple example solve equation (10) for matrices

$$A_1 = \begin{pmatrix} s+1 & 2 \\ 3 & s+2 \end{pmatrix}, B_1 = \begin{pmatrix} 1.5 \\ s+2 \end{pmatrix}, C_1 = \begin{pmatrix} 1 & 0 \\ 0 & 1 \end{pmatrix} \tag{18}$$

Matlab function *AXBYC* in Polynomial toolbox gives the particular solution

$$X_0 = \begin{pmatrix} 0 & 0.33 \\ 2 & -0.67 - 0.67s \end{pmatrix}, \tag{19}$$

$$Y_0 = (-2 \quad 0.67 + 0.67s)$$

All solution are given in the form (14) with

$$\tilde{A}_1 = \begin{pmatrix} s+1 & 2 \\ 3 & s+2 \end{pmatrix}, \tilde{B}_1 = \begin{pmatrix} 0.94 + 0.47s \\ 2.4 - 2.8s - 0.94s^2 \end{pmatrix}. \tag{20}$$

The free polynomial matrix T has the form

$$T = (t_1(s) \quad t_2(s)) \tag{21}$$

with $t_1(s), t_2(s)$ arbitrary polynomials. Really, the product $A_1\tilde{B}_1 = B_1\tilde{A}_1$ gives the same result in the form

$$\begin{pmatrix} 5.7 - 4.2s - 1.4s^2 \\ 7.5 - 1.9s - 4.7s^2 - 0.94s^3 \end{pmatrix} \quad (22)$$

which confirms equation (15).

5 Control Design

The most frequent scheme for a basic feedback control system is depicted in Fig. 1. All signals in the MIMO case are vector ones. Input signals of the feedback system in Fig. 1 is a reference (set point) signal $w = F_w^{-1}(s) G_w(s)$ and a load disturbance signal $d = F_d^{-1}(s) G_d(s)$ defined by their matrix left matrix fractions.

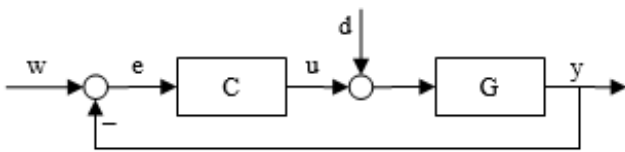

Fig. 1 one degree of freedom (1DOF) control system

All stabilizing controllers for the 1DOF feedback system in Fig. 1 are given by any solution of matrix Diophantine equation

$$A(s)P_R(s) + B(s)Q_R(s) = M(s), \quad (23)$$

where $P^{-1}(s)Q(s) = Q_R(s) P_R^{-1}(s)$ is a left and right matrix fraction of the controller C and $A^{-1}(s)B(s) = B_R(s)A_R^{-1}(s)$ is a left and right matrix fraction of the controlled plant G . More details can be found e.g. in [1], [5], [12], [15], [16].

However, for asymptotic tracking and disturbance rejection must be fulfilled further conditions. Briefly speaking, denominator of the controller must be divisible by the denominators of input signals. It is a reason for a pre-compensator F in Fig. 2 which represents the conditions of divisibility. In the case of asymptotic tracking only, it is $F=F_w$. In the case of simultaneous asymptotic tracking and disturbance rejection $F=F_wF_d$. The basic stability and asymptotic tracking in the sense of Fig. 2 is then the controller $Q_R(s)P_R^{-1}(s)$ given by the solution of matrix Diophantine equation

$$A(s)F(s)P_R(s) + B(s)Q_R(s) = M(s), \quad (24)$$

where $M(s)$ is a stable polynomial matrix with prescribed poles of its determinant. Resulting matrices P_R, Q_R represent the right matrix fraction

$$P(s)^{-1}Q(s) = Q_R(s)P_R(s)^{-1} \quad (25)$$

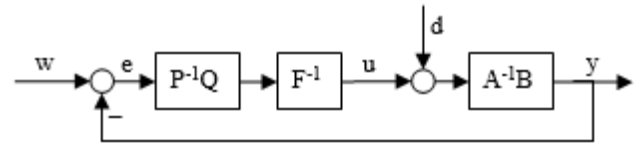

Fig. 2 feedback 1DOF control system with pre-compensator

The control law is then governed by the equation

$$P(s)^{-1}F(s)U(s) = Q(s)(W(s) - Y(s)), \quad (26)$$

which can be easily rewritten into differential equations. Now, it is necessary to propose the method for solution of matrix equation (2). For simpler cases, the solution can be found by means of elementary column operation, according to the scheme

$$\left(\begin{array}{c|c} AF & B \\ \hline I & 0 \\ \hline 0 & I \end{array} \right) \xrightarrow[\text{operations}]{\text{elementary column}} \left(\begin{array}{c|c} M & 0 \\ \hline P_R & Z_1 \\ \hline Q_R & Z_2 \end{array} \right) \quad (27)$$

Elementary column operations (27) may always lead in the way that the polynomial matrix $P_R(s)$ remains as unit matrix and the conversion (25) is trivial and also a unit one. Then no inversion in (26) is necessary and the realization of the control law is very simple. In more complex cases, the standard techniques based on Euclidean algorithms can be used, see [2], [8], [15]. More complex matrix polynomial equations can be conveniently solved by Polynomial toolbox [17] as it is shown in Section IV.

6 Illustrative Examples

Illustrative examples 1 - 3 in this contribution are first order stable, unstable and integrating ones two input – two output (TITO) systems are represented by the matrix equation

$$\begin{pmatrix} s + a_1 & a_2 \\ a_3 & s + a_4 \end{pmatrix} \begin{pmatrix} Y_1(s) \\ Y_2(s) \end{pmatrix} = \begin{pmatrix} b_1 & b_2 \\ b_3 & b_4 \end{pmatrix} \begin{pmatrix} U_1(s) \\ U_2(s) \end{pmatrix} \quad (28)$$

The stabilization matrix Diophantine equation (24) takes the form

$$\begin{pmatrix} s+a_1 & a_2 \\ a_3 & s+a_4 \end{pmatrix} \begin{pmatrix} s & 0 \\ 0 & s \end{pmatrix} \begin{pmatrix} p_1 & p_2 \\ p_3 & p_4 \end{pmatrix} + \begin{pmatrix} b_1 & b_2 \\ b_3 & b_4 \end{pmatrix} \quad (29)$$

$$\begin{pmatrix} q_1s+q_0 & q_5s+q_4 \\ q_3s+q_2 & q_7s+q_6 \end{pmatrix} = \begin{pmatrix} (s+m_0)^2 & 0 \\ 0 & (s+m_0)^2 \end{pmatrix}$$

Example 1: Let a TITO linear continuous-time system be expressed by the Laplace transform technique in the form

$$\begin{aligned} y_1'(t) + 2y_1(t) + 0.8y_2(t) &= 5u_1(t) + 6u_2(t) \\ y_2'(t) + 1.5y_2(t) + 0.6y_1(t) &= 2u_1(t) + 3u_2(t) \end{aligned} \quad (30)$$

The Laplace transform of equations (6) gives matrices A , B

$$A(s) = \begin{pmatrix} s+2 & 0.8 \\ 0.6 & s+0.6 \end{pmatrix}, \quad B(s) = \begin{pmatrix} 5 & 6 \\ 2 & 3 \end{pmatrix} \quad (31)$$

The system described in (31) is evidently stable because $\det A = s^2 + 2.6s + 0.72$ is a stable polynomial. Then the scheme (27) can be applied and the result is in the form of generalized PI controller:

$$\begin{aligned} u_1 &= q_1e_1 + q_0 \int e_1(\tau) d\tau + q_5e_2 + q_4 \int e_2(\tau) d\tau \\ u_2 &= q_3e_1 + q_2 \int e_1(\tau) d\tau + q_7e_2 + q_6 \int e_2(\tau) d\tau \end{aligned} \quad (32)$$

where controller parameters were obtained by elementary column operations according scheme (5) in the form:

$$\begin{aligned} q_1 &= 2m_0 - 0.8 & q_5 &= -4m_0 + 2.2 \\ q_0 &= m_0^2 & q_4 &= -2m_0^2 \\ q_3 &= -\frac{4}{3}m_0 + \frac{1}{3} & q_7 &= \frac{10}{3}m_0 - \frac{5.9}{3} \\ q_2 &= -\frac{2}{3}m_0^2 & q_6 &= \frac{5}{3}m_0^2 \end{aligned} \quad (33)$$

In (9) e_i are naturally tracking errors and $m_0 > 0$ is a tuning parameter influencing control behaviour.

Example 2: Let an unstable TITO linear continuous-time system can be expressed by differential equations

$$\begin{aligned} y_1'(t) + y_1(t) + y_2(t) &= u_1(t) + 0.5u_2(t) \\ y_2'(t) + 0.5y_2(t) + 2y_1(t) &= 0.8u_1(t) + 2u_2(t) \end{aligned} \quad (34)$$

and the matrix expression has the form

$$\begin{pmatrix} s+1 & 1 \\ 2 & s+0.5 \end{pmatrix} \begin{pmatrix} Y_1(s) \\ Y_2(s) \end{pmatrix} = \begin{pmatrix} 1 & 0.5 \\ 0.8 & 2 \end{pmatrix} \begin{pmatrix} U_1(s) \\ U_2(s) \end{pmatrix} \quad (35)$$

Matrix equation (27) gives the controller matrices P_R , Q_R

$$P_R = \begin{pmatrix} 1 & 0 \\ 0 & 1 \end{pmatrix} \text{ and } Q_R = \begin{pmatrix} q_1s+q_0 & q_5s+q_4 \\ q_3s+q_2 & q_7s+q_6 \end{pmatrix} \quad (36)$$

where parameters are

$$\begin{aligned} q_1 &= 2.5m_0 - 0.65 & q_5 &= -0.6m_0 - 1.1 \\ q_0 &= 1.25m_0^2 & q_4 &= -0.3m_0^2 \\ q_3 &= -m_0 - 0.75 & q_7 &= 1.25m_0 + 0.19 \\ q_2 &= -0.5m_0^2 & q_6 &= 0.625m_0^2 \end{aligned} \quad (37)$$

The form of the control law (32) is again a generalized PI controller.

Example 3: Let an integrating (also unstable) TITO linear continuous-time system can be expressed by differential equations

$$\begin{aligned} y_1'(t) + y_2(t) &= u_1(t) + 0.5u_2(t) \\ y_2'(t) + 0.5y_1(t) &= 0.6u_1(t) + 1.5u_2(t) \end{aligned} \quad (38)$$

Determinant of $A(s) = s^2 - 0.5$ is evidently an unstable one. The controller is derived in a similar way but at the right hand side of (29) is the stable matrix $M(s)$ in the form

$$M(s) = \begin{pmatrix} (s+m_1)^2 & 0 \\ 0 & (s+m_2)^2 \end{pmatrix}, \quad m_1, m_2 > 0 \quad (39)$$

The choice of different $m_i > 0$ gives the possibility of different dynamics in both controlled outputs. The control law is again in the form of (32) with the following set of parameters q_i :

$$\begin{aligned}
 q_1 &= 2.5m_1 + 0.21 & q_5 &= -0.83m_2 - 1.25 \\
 q_0 &= 1.25m_1^2 & q_4 &= -0.42m_2^2 \\
 q_3 &= -m_1 - 0.42 & q_7 &= 0.5 + 1.67m_2 \\
 q_2 &= -0.5m_1^2 & q_2 &= 0.83m_2^2
 \end{aligned}
 \tag{40}$$

The last example represents a simple asymmetrical case, a two input – one output system of the first order gives also a kind of a generalized PI controller.

Example 4: A controlled system is a two input – single output (TISO) system described by the differential equation

$$y_1'(t) - 0.5y_1(t) = 0.5u_1(t) + 1.2u_2(t)
 \tag{41}$$

System (41) is evidently an unstable one. The initial and final state of the scheme of stabilizing equation (24) is

$$\left(\begin{array}{c|cc} s^2 - 0.5s & 0.5 & 1.2 \\ \hline 1 & 0 & 0 \\ 0 & 1 & 0 \\ 0 & 0 & 1 \end{array} \right) \sim \left(\begin{array}{c|cc} s^2 + 2m_0 + m_0^2 & 0.5 & 1.2 \\ \hline 1 & 0 & 0 \\ (4m_0 + 1)s & 1 & 0 \\ 0.833m_0^2 & 0 & 1 \end{array} \right)$$

and the control law takes the form of two equations which can be also considered as a generalized PI controller

$$\begin{aligned}
 u_1(t) &= (4m_0 + 1)e_1(t) \\
 u_2(t) &= 0.833m_0^2 \int e_1(\tau) d\tau
 \end{aligned}
 \tag{42}$$

An important remark is that there exist an infinite number of feasible stabilizing controllers. It depends how to choose elementary column operations in reduction (27). Control law (42) represents proportional controller in $u_1(t)$ and an integrating one in the $u_2(t)$ control loop. Polynomial toolbox [17] gives a similar solution but not necessarily the same one.

7 Simulation Results

Matlab and Simulink offer a suitable environment for modelling and simulation of dynamic systems. The Simulink scheme for two input – two output unstable system (7) with controller (10) is depicted in Fig. 3.

Control responses of stable TITO system (Example 1) for tuning parameter $m_0=1.5$ and $m_0=3$ are shown in Fig. 4. The control responses of the unstable TITO system (example 2) for tuning parameter $m_0=1.5$ and $m_0=3$ are shown in Fig. 5.

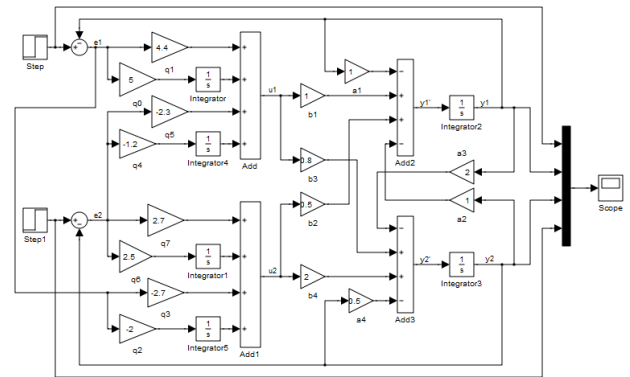

Fig. 3 simulink scheme of feedback unstable system

Examples 1 and 2 illustrate that tuning parameter $m_0 > 0$ influences the dynamical behavior of the controlled variable in the stable as well as in the unstable case. The parameter $m_0 > 0$ represents a multiple pole of the feedback characteristic polynomial.

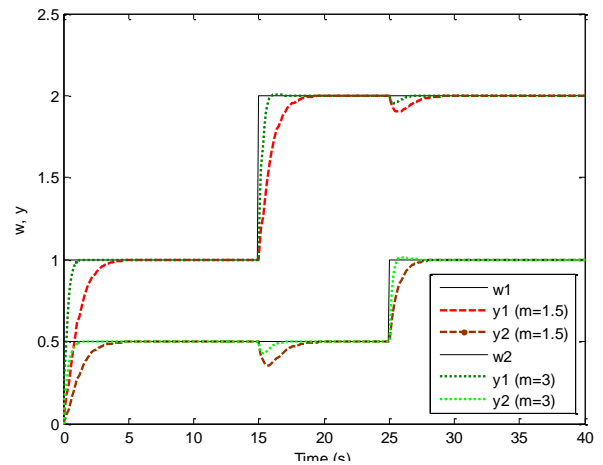

Fig. 4 control responses for $m_0=1.5$ and $m_0=3$ (Example 1)

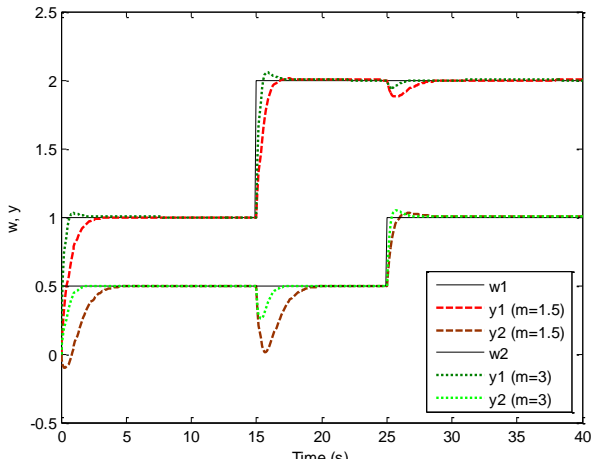

Fig. 5 control responses for $m_0=1.5$ and $m_0=3$ (Example 2)

In some cases, it can be useful every controlled variable influence in different dynamics. It is easily obtained by a different choice of poles in feedback loops. The situation is shown in Fig. 6 and Fig. 7 for TITO integrating system. While the response in Fig. 6 is for $m_1 = m_2 = 1$, the responses in Fig. 7 are for the choice $m_1 = 1.5, m_2 = 2$.

Fig. 8 and Fig. 9 illustrate control responses of the two input – single output system solved in Example 4. Tuning parameter $m_0 > 0$ again influences the control behaviour and dynamics.

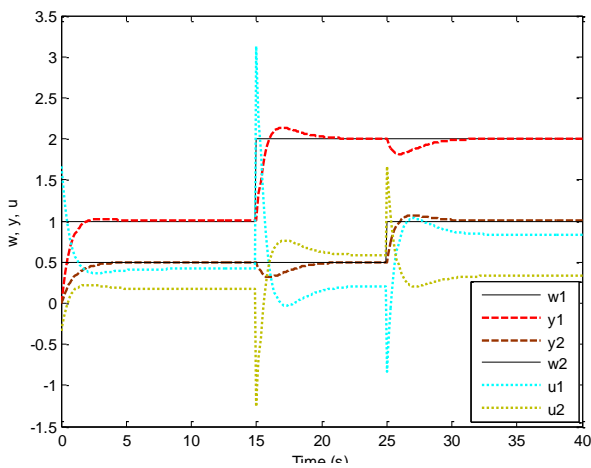

Fig. 6 control responses (Example 3) of integrating system for tuning parameters $m_1 = 1, m_2 = 1$.

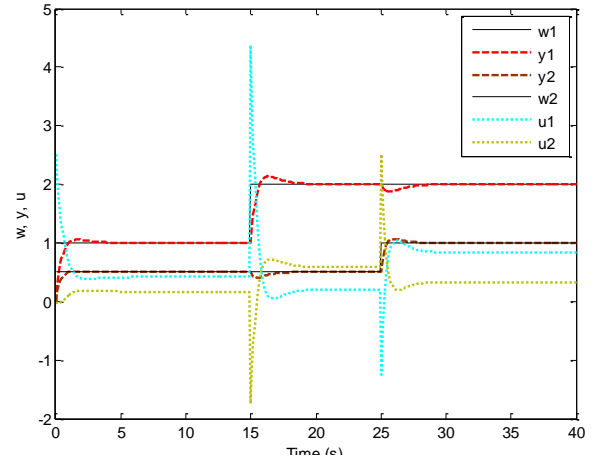

Fig. 7 control responses (Example 3) of integrating system for tuning parameters $m_1 = 1.5, m_2 = 2$.

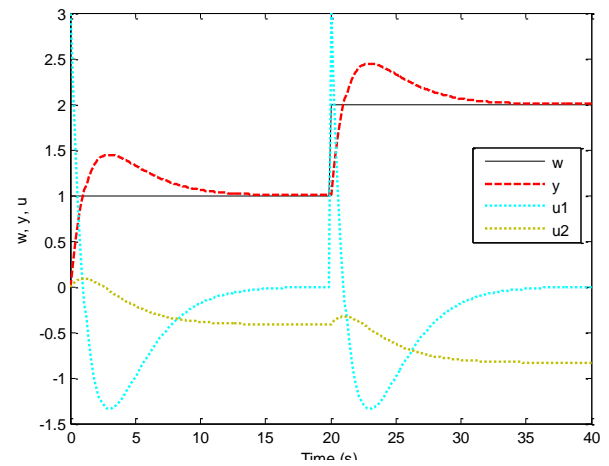

Fig. 8 control responses (Example 4) of TISO system for tuning parameters $m_0=0.5$.

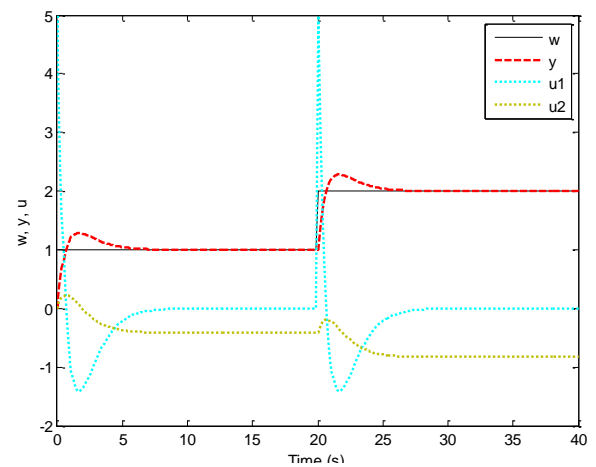

Fig. 9 control responses (Example 4) of TISO system for tuning parameters $m_0=1$.

8 Conclusion

The paper deals with multivariable control of simple continuous-time linear systems. The controller design is performed through a solution of a matrix Diophantine equation. This approach enables to define one or a couple scalar tuning parameters for influencing of control behaviour. The tuning parameters represent poles of the characteristic feedback equation. In the first order cases, the solution and a final controller can be obtained in simple and explicit form performing by elementary column operation of the given matrices. Resulting controllers then are of generalized PI controllers. All simulations and results are clearly demonstrated in the Matlab-Simulink environment.

Acknowledgement

This work was supported by the European Regional Development Fund under the project CEBIA-Tech No. CZ.11.05./2.1.00/03.0089.

References:

- [1] Kučera, V. Discrete Linear Control. The Polynomial Equation Approach. Prague: Academia, 1979.
- [2] Kučera, V. Analysis and Design of Discrete Linear Control systems. Prague: Academia, 1991.
- [3] Kučera, V. "Diophantine equations in control - A survey," Automatica, Vol. 29, (1993), pp. 1361-75.
- [4] Kaczorek, T. (1985). Two-dimensional Linear Systems. Springer-Verlag. Berlin.
- [5] M.J.Grimble and V. Kučera, Polynomial Methods for Control Systems Design. London:Springer, 1996.
- [6] A. O'Dwyer, Handbook of PI and PID controller tuning rules. London: Imperial College Press, 2003.
- [7] R. Matuš and R. Prokop, Various Approaches to Solving an Industrially Motivated Control Problem: Software Implementation and Simulation. International Journal of Mathematics and Computers in Simulations, 2012, roč. 6, č. 1, s. 161-168. ISSN 1998-0159.
- [8] T. Kailath, Linear systems, Prentice Hall 1980.
- [9] R. Prokop, N. Volkova, Z. Prokopová, Unstable systems-tracking and disturbance attenuation. WSEAS Transactions on Systems and Control, 2011, roč. 6, č. 3, s. 69-78. ISSN 1991-8763.
- [10] R. Prokop, N. Volkova, Z. Prokopová, Tracking and disturbance attenuation for unstable systems: An Algebraic Approach, In: Recent Research in Social Science, Digital Convergence, Manufacturing & Tourism. WSEAS Press, 2011, p. 161-166.
- [11] R. Prokop and J. Korbel, Multivariable Control of Unstable systems - A Matrix Diophantine Equations, in Proc. 18th Int. Conf. on Systems (CSCC'14), Santorini, Greece, p. 438-442, 2014.
- [12] Rosenwasser, E.N. and B.P. Lampe, Multivariable Computer-controlled Systems. Springer-verlag, Berlin, 2006.
- [13] K.J. Åström and R.M. Murray, Feedback Systems. Research Triangle Park, NC: Instrumental Society of America, 1995.
- [14] S. Skogestad and I. Postlethwaite: Multivariable Feedback Control. Analysis and Design. John Wiley and Sons, 1997.
- [15] Vidyasagar, M. Control system synthesis: a factorization approach. MIT Press, Cambridge, M.A., 1987.
- [16] Volkova, N. and R. Prokop, R. "Matrix equation approach for MIMO control design," in Proc. DAAAM Conf., p.225-226, 2011.
- [17] PolyX, Ltd. Polynomial Toolbox. 1998.
- [18] M. Kubalčík and V. Bobál, Computation of Predictions in Multivariable Predictive Control, in Proc. 13th Int. Conf. on Automatic Control, Modelling and Simulation(ACMOS), pp.15-20, 2011.