

# Numerical Modelling of Sinusoidal Brushless Motor for Aerospace Actuator Systems

M. D. L. DALLA VEDOVA P. MAGGIORE M. SCANAVINO

Department of Mechanical and Aerospace Engineering

Politecnico di Torino

Corso Duca degli Abruzzi 24 – 10129, Turin

ITALY

matteo.dallavedova@polito.it, matteo.scanavino@gmail.com

**Abstract:** - The interest in electromechanical actuators (EMA) has been growing because of the development of next generation aircraft, based on the More Electric design. Electromechanical actuators have been gaining increased acceptance as they are becoming more and more safety-critical actuation devices: for prognostics and health management purposes of EMA, reliable and representative simulation models are needed in order to identify failures. This paper presents a multi domain model of EMA and it focuses on the numerical modelling of the Permanent Magnet Synchronous Motor (PMSM), also known as Sinusoidal Brushless Motor. The choice of the multi domain simulation is necessary to improve the simplifying hypotheses that are typically considered in numerical models and that are mostly used for prognostic analyses of electromechanical actuators.

**Key-Words:** - PMSM, Electromechanical Actuator (EMA), Prognostics, PHM, Numerical Model

## 1 Introduction

In the last few years, the interest in brushless motors has increased because of their advantages compared with traditional brushed motors. The need of improvement in the design of electric motors was first reported during high altitude strategic bombing in World War II: in fact, at about 30000 ft, a rapid brush wear occurred [1-3]. Later on, during space exploration, the brush problem became crucial due to the outgassing phenomena. Brushless motors have been designed to overcome the brushed motor disadvantages: the electronic commutation, which is made possible by using electronic switches, replaces the mechanical commutation based on carbon made brushes. This study shows the first results of our research activity focused on the numerical modelling of the PMSM for electromagnetic aerospace actuator systems for future diagnostic and prognostic applications. For this purpose, short-circuit and static eccentricity failure conditions will be implemented in the developed PMSM model. Furthermore, the developed model takes into account dry friction and it overcomes the typical limitations (e.g. simplifying assumptions such as the superposition of the effects) which are unable to assess nonlinear effects arising from failure conditions. This purpose is achieved by means of a multi-domain numerical method which allows the development of simulation algorithms properly sensitive to faults.

## 2 EM Flight Control Actuators

Flight control systems allow to control the aircraft dynamic: this is made possible by means of the proper actuation of the flight control surfaces. The aerodynamic forces, exerted on the flight control surfaces, will result in the aircraft rotation around one of the three body axes; in the last decades, flight control actuators were generally hydromechanical or electrohydraulic but, especially in recent years, the electromechanical systems are gradually asserting (e.g. UAVs, secondary or stand-by systems). Indeed, with respect to hydraulic systems, EMAs offer many advantages: overall weight is reduced, maintenance is simplified and hydraulic fluids, which are often contaminant, flammable or polluting, can be eliminated. For these reasons, as reported in [4], the use of actuation systems based on EMAs is quickly increasing in several fields of aerospace technology.

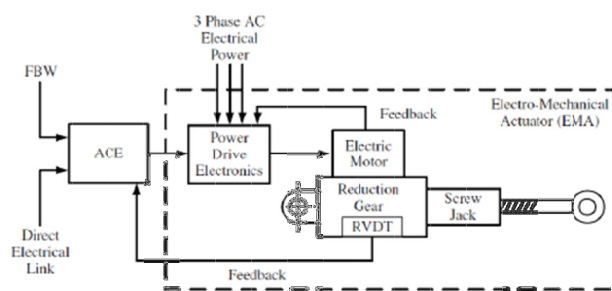

Fig. 1: Schematic of the considered EMA system

In Fig. 1, an electromechanical actuator scheme, for primary flight control, is presented. The EMA system is composed by:

1. an actuator control electronics (ACE) that closes the feedback loop, by comparing the commanded position (FBW) with the actual one; it elaborates the corrective actions and generates the reference current ( $I_{ref}$ );
2. a Power Drive Electronics (PDE) that regulates the electrical power from the aircraft electrical system to the electric motor;
3. an electric motor, often a three-phase brushless type;
4. a gear reducer that decreases the motor angular speed and increases its mechanical torque;
5. a system that transforms rotary motion into linear motion: ball screws or roller screws are usually preferred because a conversion with higher efficiency can be performed;
6. a network of sensors that are used to close the feedback loops (current, motor speed and angular position) controlling the whole actuation system (reported in Fig.1 as RVDT).

### 3 Proposed PMSM Numerical Model

The authors' models implement the motor features only (rotor speed control loop and related reference current controller, pulse-width modulation (PWM) inverter, electromagnetic model of the stator circuit and related electromechanical model, internal sensors and considered faults).

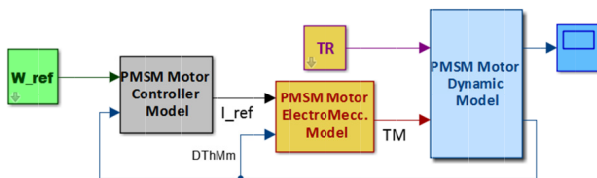

Fig. 2: Block diagram of the EMA numerical model

The proposed model is shown in Fig. 2 and it is composed by five subsystems:

1.  $W_{ref}$ : input block that generates the reference motor speed;
2. *PMSM Motor Controller Model*: it simulates the actuator control electronics closing the feedback loops and generating the reference current  $I_{ref}$ ;
3. *PMSM Motor ElectroMecc. Model*: it simulates the power drive electronics and the sinusoidal PMSM electromagnetic behaviour. Furthermore, it evaluates the mechanical torque developed by the electrical motor as a function of the voltages generated by the three-phase electrical regulator;

4. *PMSM Motor Dynamic Model*: it simulates the motor mechanical behaviour by means of a two degree-of-freedom dynamic system;
5. *TR*: input block that simulates the external load acting on the rotor shaft.

It must be noted that these numerical models can also consider the electrical noise acting on the signal lines [4], the rotor bearings dry friction and the limit switches [5]. The PMSM model is the development of the previous work carried out for the trapezoidal brushless motor BLDC [6]. A Circuitual Model with Detailed Inverter (CMDI) has been implemented: the physical data used to implement these numerical algorithms and to run the corresponding simulations are referred to the TC 40 0.32 01 Tetra Compact sinusoidal brushless motor (as reported in Table 1).

Table 1: Main PMSM data

Nominal voltage	48	[V]
Phase-phase resistance	1.10	[ $\Omega$ ]
Phase-phase inductance	0.72	[mH]
Torque constant	0.094	[Nm/A <sub>pp</sub> ]
Back-EMF constant	0.0544	[V <sub>pp</sub> /A <sub>pp</sub> ]
Stall Torque	0.34	[Nm]
Rotor Inertia	0.047	[kg cm <sup>2</sup> ]

Each phase line is characterised by the same resistance  $R$  and the same inductance  $L_{eq}$ ; moreover, the back electromagnetic force  $e_1, e_2$  and  $e_3$  are introduced: they are related to the magnetic flux  $\lambda_m$  time derivative. The layout of the numerical model is similar to the BLDC model shown in [6] but, in this case, sinusoidal functions are used to describe the back electromagnetic forces and currents.

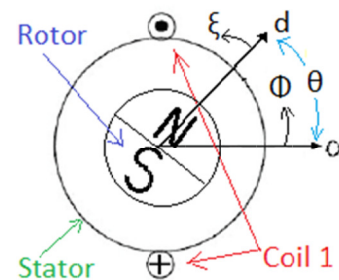

Fig. 4: Brushless Reference systems

Three different reference systems are introduced to study the PMSM (as shown in Fig. 4):

1.  $\alpha - \beta$  axes: it is a stationary reference system where the  $\alpha$  axis is fixed on the PMSM stator and it is defined by starting from the symmetrical axis of the phase 1.

- The  $\beta$  axis is perpendicular to  $\alpha$  axis so that a right handed Cartesian system is obtained. The angle  $\Phi$  is used as a polar coordinate to describe angles along the stator starting from the  $\alpha$  axis;
- $d - q$  axes: it is a rotating reference system with the rotor. The  $d$  axis points to the north pole line, while the  $q$  axis is perpendicular to the  $d$  axis. The angle  $\xi$  is a polar coordinate describing the angles along the rotor, starting from the  $d$  axis;
  - Three-phase reference system*: it is a stationary reference system where the axes (1, 2 and 3) fall into line with the three-phase windings of the motor: the axes are out of phase by  $120^\circ$  and the 1-axis corresponds to the  $\alpha$  axis.

The relative angle between the stator and the rotor axes is  $\theta$ . Applying Kirchhoff's law on each line it results that:

$$V_{1n} = Ri_1 + L_{eq} \frac{di_1}{dt} + e_1 \quad (1)$$

$$V_{2n} = Ri_2 + L_{eq} \frac{di_2}{dt} + e_2 \quad (2)$$

$$V_{3n} = Ri_3 + L_{eq} \frac{di_3}{dt} + e_3 \quad (3)$$

Moreover, for a balanced three-phase circuit:

$$i_1 + i_2 + i_3 = 0 \quad (4)$$

The motor torque is obtained from the power balance and, referred to  $d - q$  axes, it results [7]:

$$T_m = \frac{3}{2} P \lambda_m i_q \quad (5)$$

where  $P$  and  $\lambda_m$  are the pole pair number and the magnetic flux respectively.

It must be noted that, in order to obtain the three-phase reference currents from the reference  $i_q$  current, Park and Clarke transformations are needed (as described in [8]). The reference current ( $I_{ref}$ ) is obtained from the motor controller: a reference motor torque is turned into the reference current by using the motor torque

### 3.1 PMSM Electromechanical Model

The subsystem in Fig. 5 models a three-phase circuit: it receives, as input, the reference current  $I_{ref}$ , the electrical angle and the rotor mechanical speed and position. The reference current subsystem generates the reference sinusoidal currents for a three-phase circuit: the  $i_q$  and  $i_d$  reference currents are set equal to the reference current  $I_{ref}$  and zero respectively. The inverse Park and Clarke transformation matrixes are implemented to obtain the corresponding three-phase reference currents.

The PWM, Inverter, Phase Currents and Motor Torque subsystems are the same as in [6], implemented in the Circuitual Model with Detailed Inverter model. On the left bottom of Fig. 5 we can notice the normalized back electromagnetic forces, which are sinusoidal functions of the electric angle.

The back electromagnetic forces are obtained multiplying the normalized BEMFs and the motor angular speed. The *Failure Functions* subsystem implements the short circuit and static eccentricity failure as shown in [9].

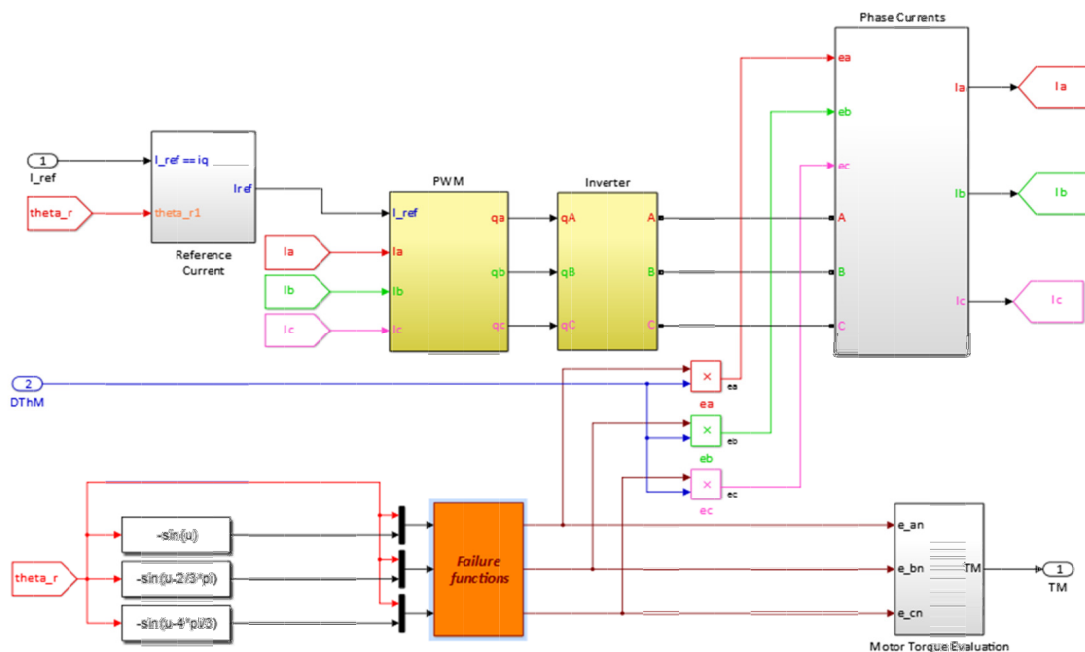

Fig. 5: PMSM Electromechanical Model subsystem

### 3.2 PMSM Speed Controller

The motor control is achieved by means of a PID speed controller [10]: the input speed error is used to define the reference torque, which is turned into the reference current  $I_{ref}$ . The derivative term acts on the signal error, properly filtered, in order to ensure the stability of the entire system: a low-pass-filter is added to the derivative line for this purpose. The integral contribution is achieved with the anti-windup filter, which allows the desaturation of the integral term when the reference torque reaches the maximum value allowed. The three gains of the said PID PMSM speed controller are shown in Table 2.

Table 2: PMSM speed controller PID gains

$K_p$ [Nm/rad/s]	$K_i$ [Nm/rad]	$K_d$ [Nm/rad/s <sup>2</sup> ]
0.025	0.235	$1e - 6$

### 4 Results

In this section, in order to explain the performance of the proposed numerical model, the motor response to a reference speed is presented, in load conditions. The reference speed is set equal to the nominal motor speed (3000 rpm). An external load (50% of the stall torque) is applied at time  $t = 0.15$  s. Fig. 7 shows the motor speed time history, while in Fig. 8 the BEMFs and the actual three-phase currents are shown. It can be noticed that the phase currents increase when the external load is applied; at the same time, a reduction in the BEMFs is visible, due to the proportional relationship between the motor speed and BEMFs. In Fig. 9 the sinusoidal waveform of the actual three phase currents and the reference ones are shown. The motor torque time history is shown in Fig. 10.

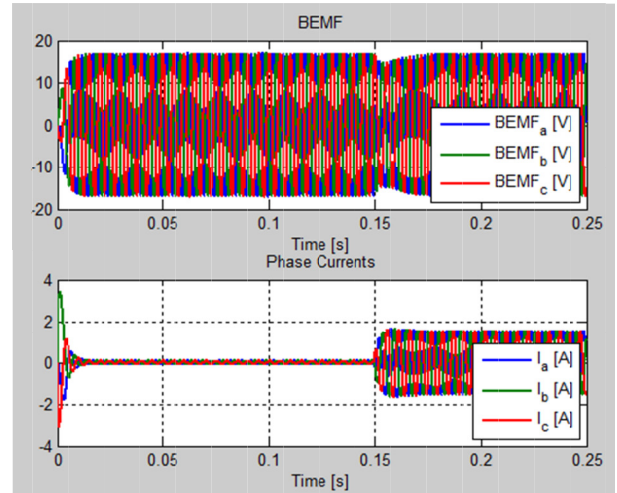

Fig. 8: BEMFs and phase currents

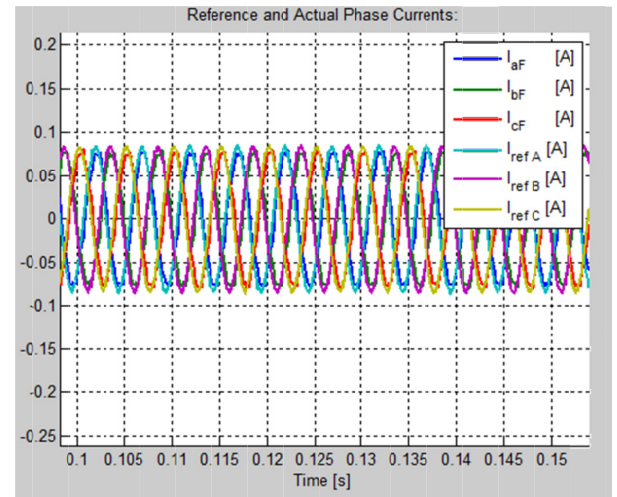

Fig. 9: PMSM reference and actual phase currents

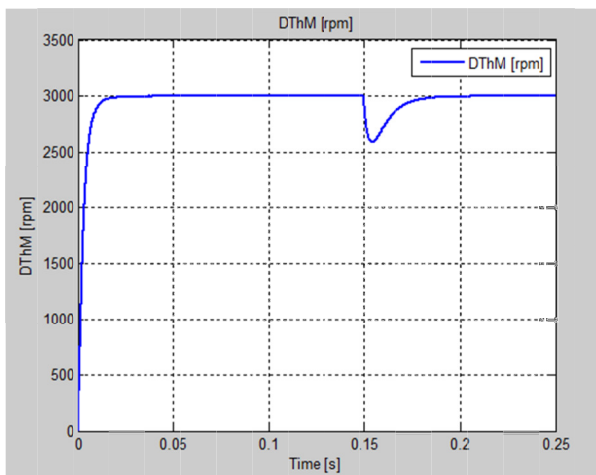

Fig. 7: PMSM motor speed time history

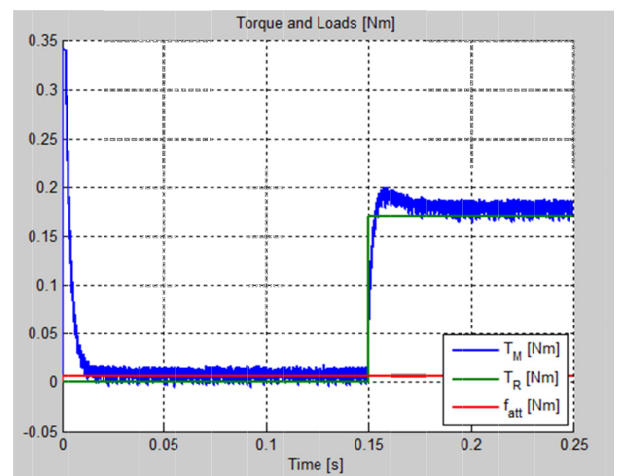

Fig. 10: PMSM motor torque  $T_M$ , external load  $T_R$  and friction torque  $f_{att}$  time history

## 5 Conclusions

The numerical modelling of the electromechanical actuator using permanent magnet synchronous motor has been developed. The model was created in Matlab/Simulink environment. The Park and the Clarke transformations were introduced to describe the three-phase reference currents. The sinusoidal waveform of the normalized back electromagnetic force was introduced in order to describe the correct motor behaviour and evaluate the total motor torque. The PMSM motor control was developed imposing the reference quadrature current  $i_q$  and setting the direct current  $i_d$  equal to zero, as it normally does not contribute to the motor torque generation. In order to improve the developed model, some suggestions are given:

1. the Hysteresis Control should be replaced with the d-q axes direct control, in order to avoid the phase voltage and current distortions at high rotor speed;
2. the failure conditions could be studied in details. Demagnetisation failure could be considered in order to improve the failure conditions;
3. a simplified model of the actuator should be developed in order to monitor the motor actual behaviour. This solution would be interesting for future diagnostic and prognostic applications.

## References:

- [1] Midwest Research Institute – NASA, *Brushless DC Motors*, January 1975.
- [2] NASA Practice No. PD-ED-1229, *Selection of electric motors for aerospace applications*.
- [3] P. Pillay, R. Krishnan, Application Characteristics of Permanent Magnet Synchronous and Brushless dc Motors for Servo Drives, *IEEE Transactions on industry applications*, Vol.21, No.5, September/October 1991.
- [4] D. Belmonte, M. D. L. Dalla Vedova, P. Maggiore, New prognostic method based on spectral analysis techniques dealing with motor static eccentricity for aerospace electro-mechanical actuators, *WSEAS Transactions On Systems*, Vol.14, 2015, ISSN: 1109-2777.
- [5] L. Borello, M. D. L. Dalla Vedova, G. Jacazio, M. Sorli, A Prognostic Model for Electro-hydraulic Servovalves, *Annual Conference of the Prognostics and Health Management Society*, San Diego, CA, USA, 2009.
- [6] L. Pace, M. D. L. Dalla Vedova, P. Maggiore, S. Facciotto, Numerical methods for the electromagnetic modelling of actuators for primary and secondary flight controls, *Computational Science and Systems Engineering*, Vol.58, pp. 126-133, 2016. ISSN: 1790-5117
- [7] P. Moreton, *Industrial Brushless Servomotors*, Newnes, January 2000.
- [8] S. Chattopadhyay, M. Mitra, S. Sengupta, *Electric Power Quality*, Springer, Cap. 12.
- [9] M. D. L. Dalla Vedova, P. Maggiore, L. Pace, A. Desando, Evaluation of the correlation coefficient as a prognostic indicator for electromechanical servomechanism failures, *International Journal of Prognostics and Health Management*, Vol.6, No.1, 2015. ISSN: 2153-2648.
- [10] M. H. Rashid, *Power electronics handbook, 3<sup>rd</sup> Edition*, Butterworth-Heinemann, 2011.