

Firefly Algorithm Based Speed Control of DC Series Motor Powered by Photovoltaic System

E. S. Ali^{1,2}

¹Electric Power and Machine Department, Faculty of Engineering, Zagazig University, Zagazig, Egypt.

E-mail address: ehabsalimalisalama@yahoo.com

²Electrical Department, Faculty of Engineering, Jazan University, Jazan, Kingdom of Saudi Arabia

E-mail address: esalama@jazanu.edu.sa

Abstract- This paper presents the speed control of DC series motor supplied by Photovoltaic (PV) system. The proposed design problem of speed controller is formulated as an optimization problem. Firefly Algorithm (FA) is employed to search for optimal Proportional Integral (PI) parameters of speed controller by minimizing the time domain objective function. The performance of the proposed FA based speed control of DC series motor has been compared with Genetic Algorithm (GA) and the Conventional PI controller tuned by Ziegler Nichols (ZN) under various operating conditions and disturbances. The results of the proposed FA are demonstrated through time domain analysis, and various performance indices. Simulation results have shown the validity of the proposed technique in controlling the speed of DC series motor over GA and conventional algorithm.

Key-Words: DC Series Motor; Firefly Algorithm; Genetic Algorithm; Photovoltaic System; PI Controller; Speed Control.

1. Introduction

DC series motors are widely used in traction and application that required high starting torque [1-2]. Due to the inherent characteristic possessed by the DC motor system, such as the complexity of the nonlinear system, unavailability of an accurate and precise mathematical model, the use of conventional PI controller become a suitable solution due to small steady-state error and low costs. However, searching the parameters of PI controller is not an easy task, particularly under varying load conditions, parameter changes and abnormal modes of operation [3-4].

Photovoltaic (PV) system refers to an array of cells containing a solar photovoltaic material that converts solar radiation into direct current electricity. Solar PV systems work by converting light into electrical power. This is achieved using a thin layer of semi-conducting material, most commonly silicon, enclosed in a glass or plastic casing. When exposed to sunlight the semi-conducting material causes electrons in the materials' atoms to be knocked loose. The electrons that are knocked loose then flow through the material to produce an electric current known as a DC. The DC is carried through wiring to an inverter which converts the current to AC so it can be connected to main electricity distribution board which either used within the home or fed back into the national grid [5-7]. PV is used in this paper to power DC series motor.

Artificial Intelligence (AI) has been discussed in literatures to solve problems related to speed control of DC motor. Artificial Neural Network (ANN) is addressed in [8-11]. The ANN approach has its own advantages and disadvantages. The performance of the system is improved by ANN based controller but, the main problem of this controller is the long training time, the selecting number of layers and the number of neurons in each layer. Another AI approach likes Fuzzy Logic Control (FLC) has received much attention in control applications. In contrast with the conventional techniques, FLC formulates the control action of a plant in terms of linguistic rules drawn from the behaviour of a human operator rather than in terms of an algorithm synthesized from a model of the plant [12-13]. It offers the following merits: it does not require an accurate model of the plant; it can be designed on the basis of linguistic information obtained from the previous knowledge of the control system and gives better performance results than the conventional controllers. However, a hard work is inevitable to get the effective signals when designing FLC. Also, it requires finer tuning and simulation before operations.

Recently, global optimization techniques have attracted the attention in the field of controller parameter optimization and enhancing speed tracking system. Tabu Search (TS) is discussed in [14] to design a robust controller for Induction

Motor. However, it appears to be effective for the design problem, the efficiency is reduced by the use of highly epistatic objective functions (i.e. where parameters being optimized are highly correlated), and the large number of parameters to be optimized. Furthermore, it is time consuming method. Another heuristic technique like Genetic Algorithm (GA) is illustrated in [15] for optimal design of speed control of Switched Reluctance Motor (SRM). Despite this optimization technique requires a very long run time that may be several minutes or even several hours depending on the size of the system under study. Swarming strategies in fish schooling and bird flocking are used in the Particle Swarm Optimization (PSO) and presented in [16] for optimal design of speed control of different motors [17-19]. However, PSO suffers from the partial optimism, which causes the less exact at the regulation of its speed and the direction. In addition, the algorithm cannot work out the problems of scattering and optimization [20, 21]. Also, the algorithm pains from slow convergence in refined search stage, weak local search ability and algorithm may lead to possible entrapment in local minimum solutions. A relatively newer evolutionary computation algorithm, called Bacteria Foraging (BF) scheme has been presented by [22–24] and further established recently by [25–29], but the BF algorithm depends on random search directions which may lead to delay in reaching the global solution. A new metaheuristic nature inspired algorithm, called Firefly Algorithm (FA), which was developed by Xin She Yang [30-32] to describe a solution for many optimization problems. First some artificial firefly are randomly distributed in the problem space, and then any firefly emit light, the intensity of which is in conformity to the optimization rate of the point the firefly stands on. Then the light intensity of any firefly is compared to the light intensity of the fireflies and the low light firefly goes toward the intense lighted one. Also the most intense firefly moves around the problem for finding the global optimized answer randomly. So, in FA the fireflies get in relationship with each other via the light. The combination of these operations leads to the movement of the all fireflies toward the more optimized points [33-34].

This paper proposes FA for speed control of DC series motor supplied by PV system. FA is used for tuning the PI controller parameters to control the duty cycle of DC/ DC converter and therefore speed control of DC series motor. The design problem of the proposed controller is formulated as an optimization problem and FA is employed to search

for optimal controller parameters. By minimizing the time domain objective function representing the error between reference speed and actual one is optimized. The effectiveness of the proposed controller is tested under different operating conditions in comparison with the GA based PI controller and conventional one through time domain simulation and some performance indices. Simulation results show that the proposed algorithm achieves good robust performance for speed tracking system under different operating conditions and disturbances.

2. System under Study

The system under study consists of PV system acts as a voltage source for a connected DC series motor. The input of PV system is the ambient temperature and radiation, while the output is the DC voltage. The proposed controller based on FA is used to control the duty cycle of DC/DC converter and consequently the voltage and speed of DC series motor. The schematic block diagram is shown in Fig. 1.

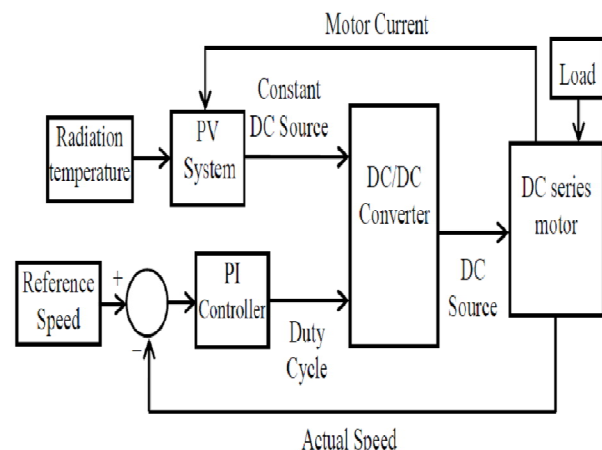

Fig. 1. Block diagram of overall system.

2.1 DC Series Motor Construction

The proposed system can be simulated with proper mathematic modeling. The DC series motor can be written in terms of equations as follows [35-40]. The parameters of DC series motor are shown in appendix.

$$\frac{di_a(t)}{dt} = \frac{V_t(t)}{L_a + L_f} - \frac{R_a + R_f}{L_a + L_f} i_a(t) - \frac{M_{af}}{L_a + L_f} i_a(t) \omega_r(t) \quad (1)$$

$$\frac{d\omega_r(t)}{dt} = \frac{M_{af}}{J_m} i_a^2(t) - \frac{f}{J_m} \omega_r(t) - \frac{T_L}{J_m} \quad (2)$$

where

- i_a The armature current,
- V_t The motor terminal voltage,
- R_a, L_a The armature resistance and inductance,
- R_f, L_f The field resistance and inductance,
- ω_r The motor angular speed,
- J_m The moment of inertia,
- T_L The load torque,
- f The friction coefficient,
- M_{af} The mutual inductance between the armature and field.

2.2 Photovoltaic Modelling

The PV cell model is composed of photovoltaic current source that has directly proportional with the sunlight intensity parallel with a diode and a small series contact resistance as shown in Fig. 2. The output current and voltage from the cell is dependent on the load operating point. The solar cell mathematical modelling is given by the following equations [6-7].

$$I_c = I_{ph} - I_o \left\{ e^{\left[\frac{q_o}{AKT} (V_c + I_c R_s) \right]} - 1 \right\} \quad (3)$$

$$V_c = \frac{AKT}{q_o} \ln \left(\frac{I_{ph} + I_o - I_c}{I_o} \right) - I_c R_s \quad (4)$$

$$I = I_{ph} - I_o \left\{ e^{\left[\frac{q_o}{n_s AKT} (V + n_s I R_s) \right]} - 1 \right\} \quad (5)$$

$$V = \frac{n_s AKT}{q_o} \ln \left(\frac{I_{ph} + I_o - I}{I_o} \right) - n_s I R_s \quad (6)$$

where;

$$I_{ph} = \frac{G}{1000} [I_{sc} + k_i (T - T_r)] \quad (7)$$

$$I_o = I_{or} \left(\frac{T}{T_r} \right)^3 e^{-\left[\frac{q_o E_g}{AK} \left(\frac{1}{T_r} - \frac{1}{T} \right) \right]} \quad (8)$$

The module output power can be determined simply from the following equation.

$$P = V.I \quad (9)$$

where;

- I, V Module output current and voltage,
- I_c, V_c Cell output current and voltage,
- I_{ph}, V_{ph} The light generation current and voltage,
- I_s Cell reverse saturation current,
- I_{sc} The short circuit current,
- I_o The reverse saturation current,
- R_s The module series resistance,
- T Cell temperature,
- K Boltzmann's constant,
- q_o Electronic charge,
- KT (0.0017 A/°C) short circuit current temperature coefficient,
- G Solar illumination in W/m^2 ,
- E_g Band gap energy for silicon,
- A Ideality factor,
- T_r Reference temperature,
- I_{or} Cell rating saturation current at T_r ,
- n_s Series connected solar cells,
- k_i Cell temperature coefficient.

Thus, if the module parameters such as module series resistance (R_s), reverse saturation current (I_o), and ideality factor (A) are known, the I-V characteristics of the PV module can be simulated by using equations (5 and 6).

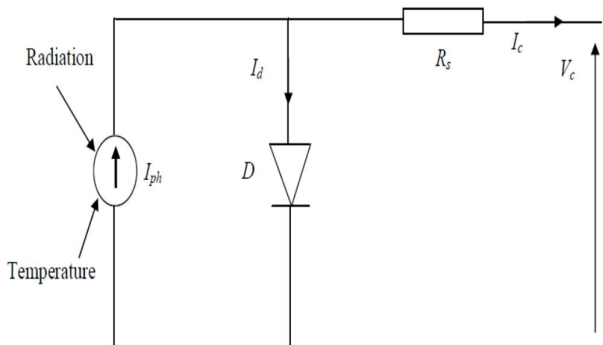

Fig. 2. Solar cell equivalent circuit.

2.3 DC-DC Converter

Many converters have been used and tested; buck converter is a step down converter, while boost converter is a step up converter [37]. In this paper, a hybrid (buck and boost) DC/DC converter is used.

The equations for this converter type in continuous conduction mode are:

$$V_B = \frac{-k}{1-k} V_{ph} \quad (10)$$

$$I_B = \frac{k-1}{k} I_{ph} \quad (11)$$

where k is the duty cycle of the Pulse Width Modulation (PWM). V_B , I_B are the output converter voltage and current respectively.

3. Objective Function

A performance index can be defined by the Integral of Time multiply Square Error (ITSE) [41-42]. Accordingly, the objective function J is set to be:

$$J = \int_0^{\infty} t e^2 dt \quad (12)$$

where $e = w_{reference} - w_{actual}$

Based on this objective function J optimization problem can be stated as: Minimize J subjected to:

$$K_p^{\min} \leq K_p \leq K_p^{\max}, K_I^{\min} \leq K_I \leq K_I^{\max} \quad (13)$$

Typical ranges of the optimized parameters are [0.001-10] for K_p and K_I . This paper focuses on optimal tuning of PI controller for speed tracking of DC series motor using FA. The aim of the optimization is to search for the optimum controller parameters setting that minimize the difference between reference speed and actual one.

4. Overview of Firefly Algorithm

FA is a metaheuristic algorithm which has been presented by Xin She Yang [30-32]. This algorithm is inspired by the mating or flashing behavior of fireflies. These fireflies belong to a family of insects that are capable to produce natural light to attract a mate or prey. This light appears to be in a unique pattern and produce an amazing sight in the tropical areas during summer. The intensity (L) of light decreases as the distance (r) increases and thus most fireflies can communicate only up to several hundred meters. In the implementation of the algorithm, the flashing light is formulated in such a way that it gets associated with the objective function to be optimized. For simplicity, some rules are used to extend the structure of FA.

1. A firefly will be attracted by other fireflies regardless of their sex.

2. Attractiveness is proportional to their brightness and decreases as the distance among them increases.
3. The value of the objective function determines the brightness of a firefly [32-34].

FA depends on two important factors: the variation of the light intensity and the formulation of the attractiveness.

- **Light Intensity and Attractiveness**

The attractiveness β of a firefly is given by its light intensity L , which is proportional to the value of objective function. As the light intensity decreases with the distance from its source, the attractiveness changes with the distance r_{ij} between firefly i and firefly j . Light is also absorbed by the media. When the medium is known, the light intensity of one firefly can be specified by the following equation.

$$L(r) = L_0 e^{-\gamma r^2} \quad (14)$$

where γ is the absorption coefficient, and L_0 is its initial brightness, namely its brightness at $r = 0$.

The attractiveness of a firefly is determined by equation (15) where β_0 is the attractiveness at $r = 0$.

$$\beta = \beta_0 e^{-\gamma r^m}, \quad (m \geq 1) \quad (15)$$

- **Distance**

The distance between any two fireflies i and j at x_i and x_j respectively, the Cartesian distance is determined by equation (16) where $x_{i,k}$ is the k^{th} component of the spatial coordinate x_i of the i^{th} firefly and d is the number of dimensions.

$$r_{ij} = \sqrt{\sum_{k=1}^d (x_{i,k} - x_{j,k})^2} \quad (16)$$

- **Position Update**

Position update when firefly i is attracted to another more attractive firefly j , which is determined by the following equation.

$$x_i = x_i + \beta_0 e^{-\gamma_{ij}^2} (x_j - x_i) + \alpha \epsilon \quad (17)$$

where the second term is due to the attraction while the third term is randomization with α being the randomization parameter and ϵ being the vector of

random numbers drawn from a Gaussian distribution. The parameter γ characterizes the contrast of the attractiveness and its value varies from 0.1 to 10 determining the convergence speed of the FA. It is worth pointing out that FA achieves the global optimization by fireflies' continuous updating position based on the brightness and attraction.

• **Convergence of Algorithm**

For any large number of fireflies (n), if $n \gg m$, where m is the number of local optima of an optimization problem, the convergence of the algorithm can be reached. Here, the initial location of n fireflies is distributed uniformly in the entire search space, and as the iterations of the algorithm continue fireflies converge into all the local optimum. By comparing the best solutions among all these optima, the global optima are reached. The flow chart of FA is shown in Fig. 3. The parameters of FA are shown in appendix.

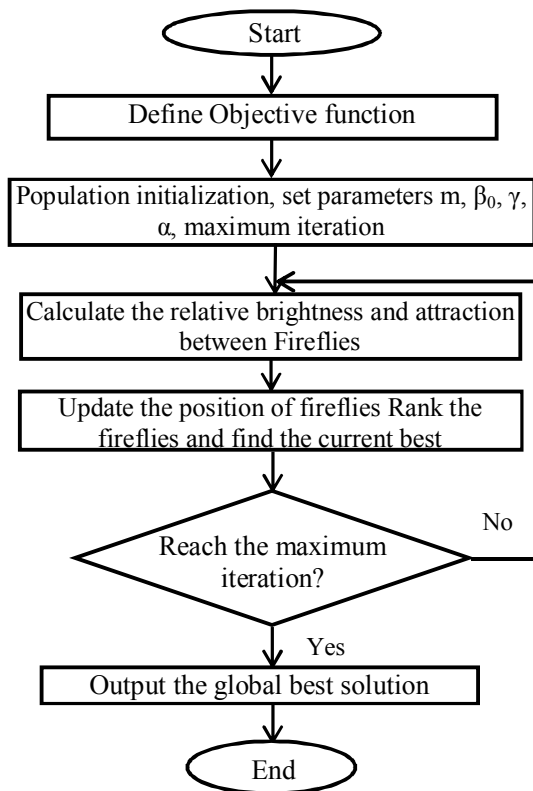

Fig. 3. Flow chart of FA.

5. Results and Discussion

In this section, different comparative cases are examined to show the effectiveness of the proposed FA controller compared with GA [43-45] and ZN under change of load torque, ambient temperature

and radiation variations. The designed parameters of PI controller with the proposed FA, conventional approach and GA are given in Table 1. Also, Fig. 4 shows the minimum fitness functions evaluating process using the FA method. Moreover, FA converges at a faster rate (45 generations) compared to that for GA (61 generations). Moreover, computational time (CPU) of both algorithms is compared based on the average CPU time taken to converge the solution. The average CPU for FA is 39.8 second while it is 50.3 second for GA. The proposed FA methodology and GA are programmed in MATLAB 7.1 and run on an Intel(R) Core(TM) I5 CPU 2.53 GHz and 4.00 GB of RAM. The mentioned CPU time is the average of 10 executions of the computer code.

Table. 1. Comparison between various controllers.

	K_P	K_I
FA	0.0879	2.1134
GA	0.0849	2.0928
ZN	0.0765	1.5736

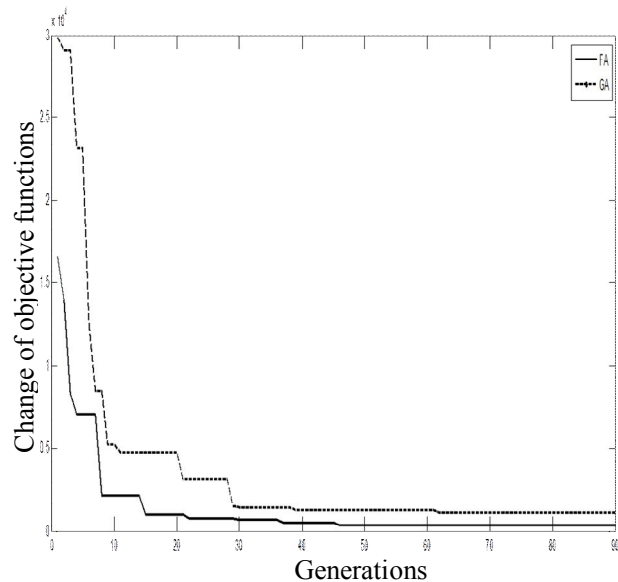

Fig. 4. Objective function for both algorithms.

5.1 Response under step change of temperature

Figs. 5-6 show the step change of load torque, the current, voltage and power of PV system. The speed response under variation of the load torque is shown in Fig. 7 respectively. The actual speed tracks the reference speed with minimum overshoot and settling time. The settling time is approximately 0.03 second. Moreover, the speed response is faster with the proposed controller than GA and ZN for the step variation of load torque. In additional, the designed controller is robust in its operation and

gives a superb performance compared with conventional PI controller and GA tuning PI controller.

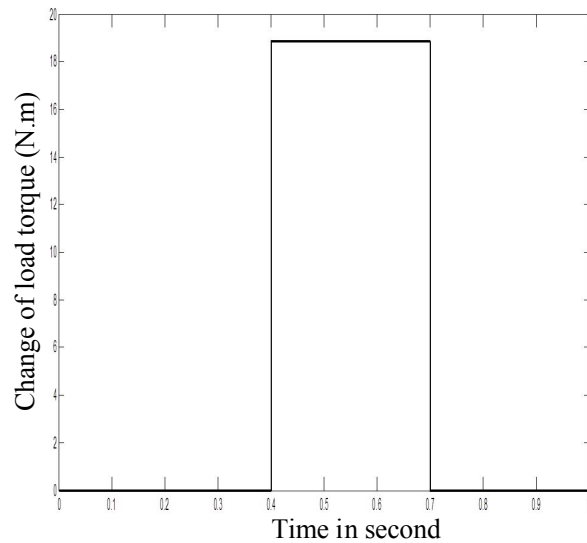

Fig. 5. Step change of load torque.

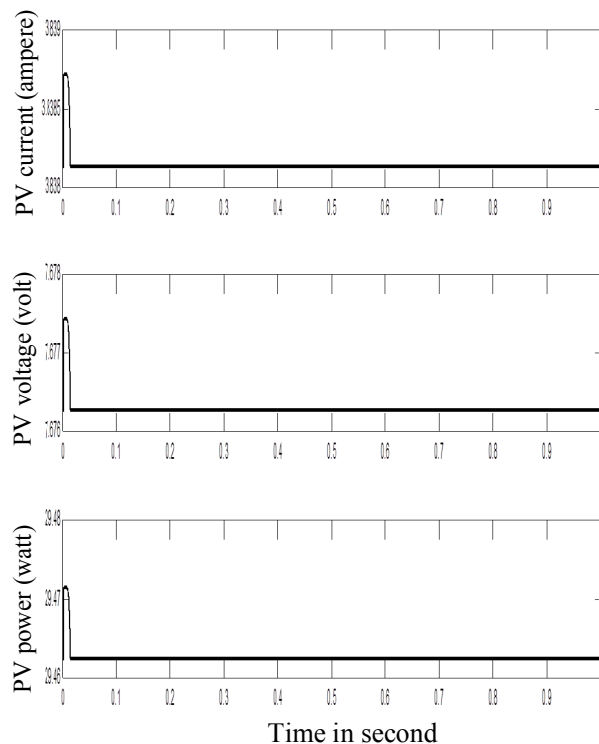

Fig. 6. The PV current, voltage and power.

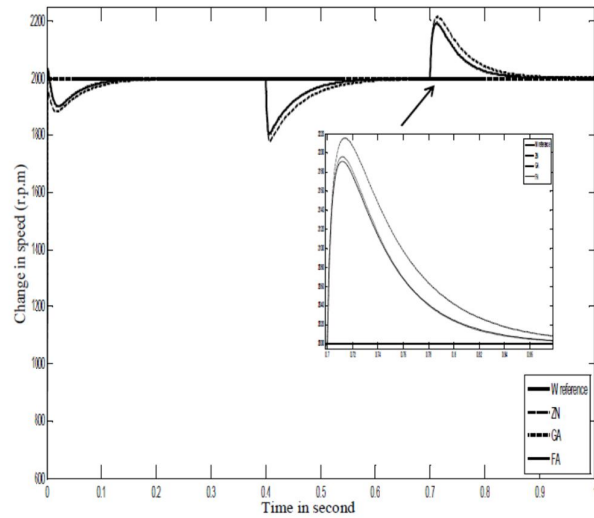

Fig. 7. Change in speed for different algorithms.

5.2 Response under step change of radiation

In this case, the system responses under variation of PV system radiation are obtained. Figs. 8-9 show the variation of the PV system radiation as an input disturbance and the current, voltage and power of PV system respectively. Moreover, the system response based on different algorithms is shown in Fig. 10. It is clear from these Figs., the proposed FA based controller improves the speed control of DC series motor effectively. Moreover, the proposed method outperforms and outlasts GA in designing speed controller and reducing settling time. Hence, PI based FA greatly enhances the performance characteristics of DC series motor compared with those based GA and conventional technique.

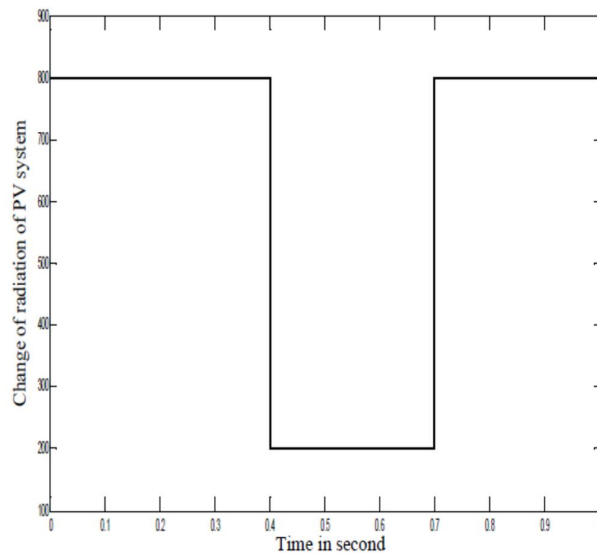

Fig. 8. Step change for PV system radiation.

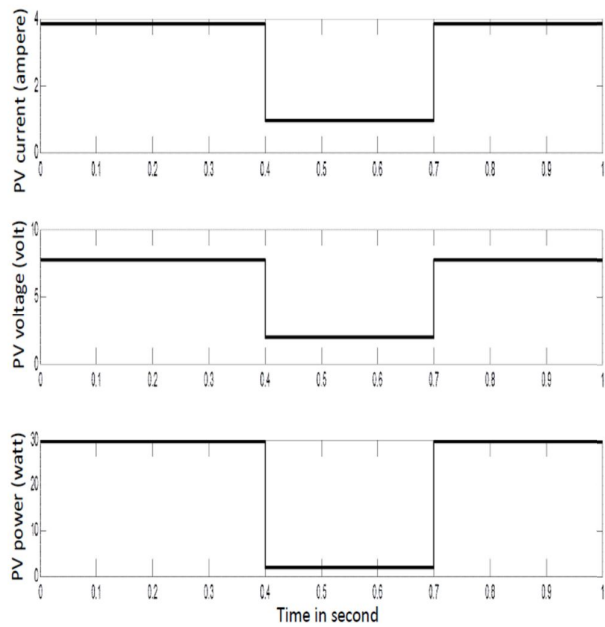

Fig. 9. The PV current, voltage and power.

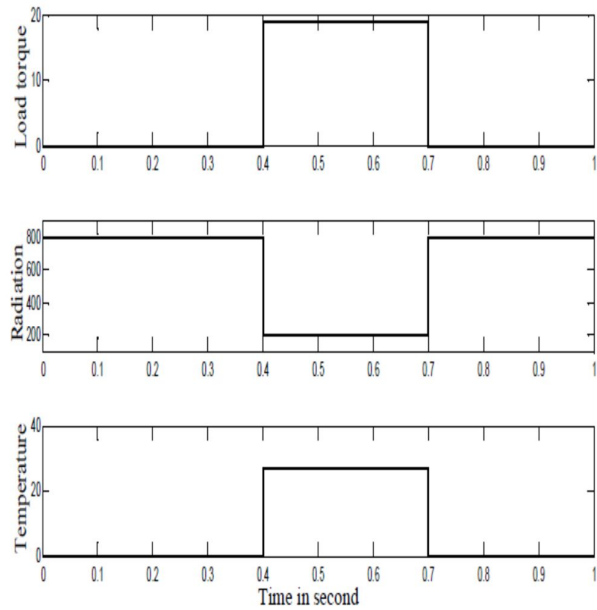

Fig. 11. Step change of load torque, PV system radiation and temperature.

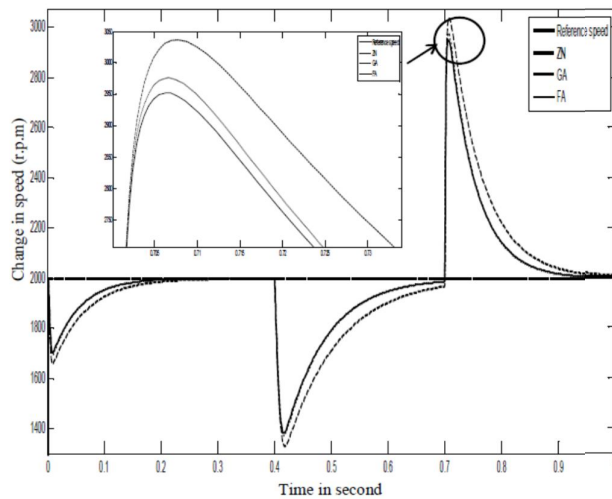

Fig. 10. Change in speed for different controllers.

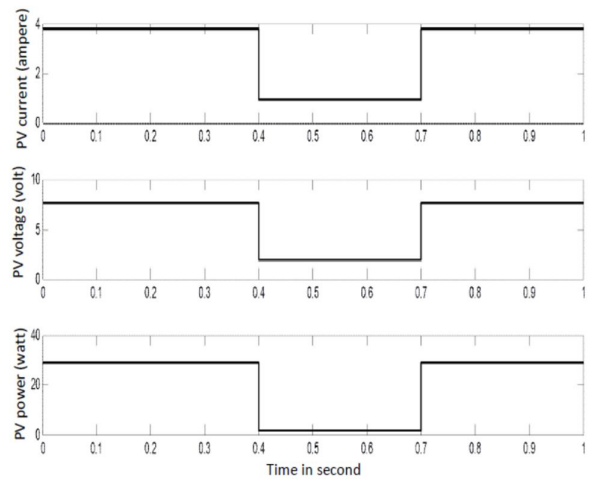

Fig. 12. The PV current, voltage and power.

5.3 Response under step change of load torque, radiation and temperature

The effect of applying step change of load torque, radiation and temperature of PV system is shown in this case. Figs. 11-12 illustrate the variation of load torque, radiation, temperature and the output of PV system. A comparison between the actual and reference speed is shown in Fig. 13. From these figures, the steady state and dynamic operation of DC series motor in terms of over shoot and settling time has been enhanced. Also, the proposed controller using time domain objective functions achieves good robust performance and provides superior speed controller in comparison with the conventional technique and GA.

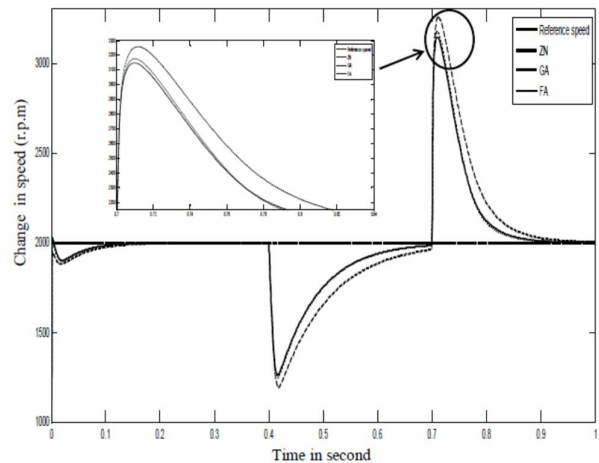

Fig. 13. Change of speed for different controllers.

5.4 Response under change of load torque, radiation and temperature

In this case, the system response under large change of load torque, radiation and temperature is obtained. Figs. 14 -15 show the change of load torque, and parameters of PV system respectively. Moreover, the effect of the proposed FA controller on speed response is illustrated in Fig. 16. It is clear from this Fig, that the proposed FA controller is robust in tracking reference speed. Also, the proposed controller has a small settling time and system response is quickly driven with the reference speed. Hence, the potential and superiority of the proposed algorithm over the classical approach and GA is demonstrated.

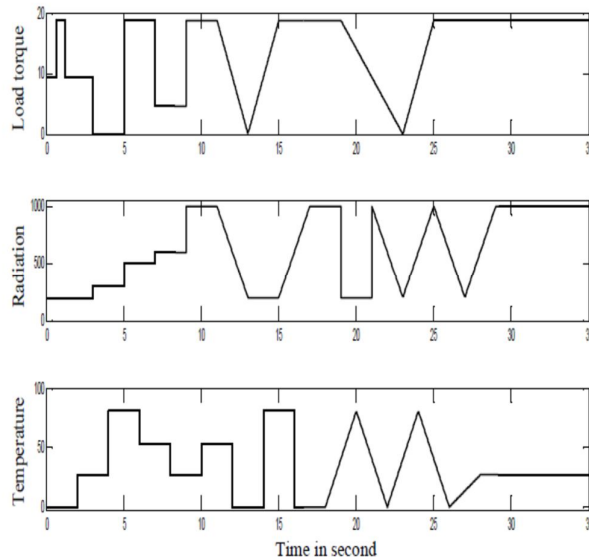

Fig. 14. Change of load torque, PV radiation and temperature.

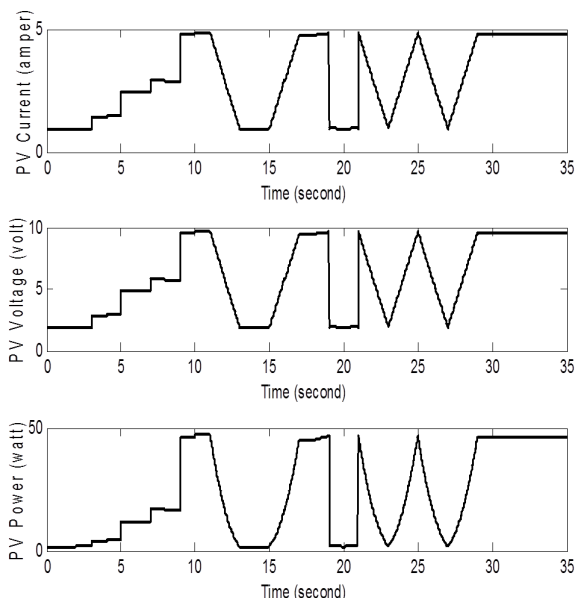

Fig. 15. The PV current, voltage and power.

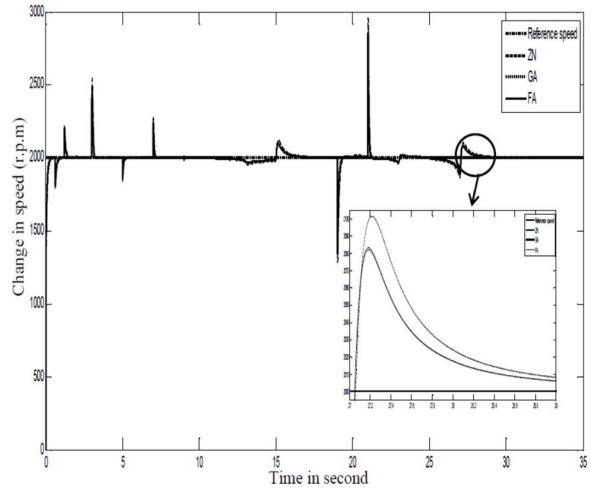

Fig. 16. The change in speed with different controllers.

5.5 Robustness and performance indices:

To demonstrate the robustness of the proposed controller, some performance indices: the Integral of Absolute value of the Error (IAE), the Integral of the Time multiplied Absolute value of the Error (ITAE), the Integral of Square Error (ISE) and the Integral of the Time multiplied of Square Error (ITSE) are being used as:

$$IAE = \int_0^{t_{sim}} |e| dt \tag{18}$$

$$ITAE = \int_0^{t_{sim}} t|e| dt \tag{19}$$

$$ISE = \int_0^{t_{sim}} e^2 dt \tag{20}$$

$$ITSE = \int_0^{t_{sim}} te^2 dt \tag{21}$$

where t_{sim} is the time of simulation and equals to 35 second. It is noteworthy that the lower the value of these indices is, the better the system response in terms of time domain characteristics [46]. Numerical results of performance robustness for all controllers are listed in Table (2) under large change of load torque, and parameters of PV system. It can be seen that the values of these system performance with the FA are smaller compared with those of GA and ZN. This demonstrates that the overshoot, settling time and speed deviations of all units are greatly decreased by applying the proposed FA based tuned PI. Eventually; values of these indices are smaller than those obtained by BF in [29].

Table. 2. Values of performance indices.

	Performance indices			
	IAE	ITAE	ISE	ITSE
FA	50.2122	758.8619	948.8979	10617
GA	54.2865	820.4309	1110.5	12524
ZN	71.4856	1075.8	1582.9	18452
BF	53.7316	811.8726	1075.4	12120

6. Conclusions

In this paper, a novel method for speed control of DC series motor is proposed via FA. The design problem of the proposed controller is formulated as an optimization problem and FA is employed to search for optimal parameters of PI controller. By minimizing the time domain objective function, in which the difference between the reference and actual speed are involved; speed control of DC series motor is enhanced. Simulation results emphasize that the designed FA tuning PI controller is robust in its operation and gives a superb performance for the change in load torque, radiation, and temperature compared with GA and conventional technique. Moreover, the system performance characteristics in terms of various performance indices reveal that the proposed controller confirms its effectiveness than GA, BF and conventional one.

Appendix

The system data are as shown below:

a) DC series motor parameters are shown below.

DC motor parameters	Value
Motor rating	3.5 HP
Motor rated voltage	240 V
Motor rated current	12 A
Inertia constant J_m	0.0027 Kg-m ²
Damping constant B	0.0019 N.m.Sec./rad
Armature resistance R_a	1.63 Ω
Armature inductance L_a	0.0204 H
Motor Speed	2000 rpm
Full load torque	19 N. m

b) The parameters of FA: $\gamma=1.0$; $\beta_0=0.1$; $\alpha=0.1$; maximum number of generations=100; number of fireflies=50.

c) The parameters of GA are as follows: Max generation=100; Population size=50; Crossover probabilities=0.75; Mutation probabilities =0.1.

References

- [1] G. K. Dubey, "Fundamentals of Electric Drives", Narosa Publishing House New Delhi, 1989.
- [2] M. H. Rashid, "Power Electronics Circuits Devices and Applications", Prentice Hall, 3rd edition, 2003.
- [3] P. T. Krein, "Elements of Power Electronics", Oxford University Press, 1998.
- [4] N. S. Kumar, V. Sadasivam, K. Prema, "Design and Simulation of Fuzzy Controller for Closed Loop Control of Chopper Fed Embedded DC Drives", IEEE Int. Conf. on Power System Technology, POWERCON 2004, Singapore, 21-24, November 2004, Vol.1, pp. 613 - 617.
- [5] C. F. Lu, C. C. Liu, and C. J. Wu, "Dynamic Modeling of Battery Energy Storage System and Application to Power System Stability", IEE Proceedings Generation, Transmission & Distribution, Vol. 142, No. 4, July 1995, pp. 429-435.
- [6] K. Hussein, I. Muta, T. Hoshino and M. Oskada, "Maximum Photovoltaic Power Tracking; An Algorithm for Rapidly Changing Atmospheric Conditions", IEEE Proceedings Generation, Transmission and Distribution, Vol. 142, No. 1, 1995, pp. 59 -64.
- [7] M. M. Saied and A. A. Hanafy, "A Contribution to the Simulation and Design Optimization of Photovoltaic Systems", IEEE Transaction on Energy Conversion, Vol. 6, September 1991, pp. 401-406.
- [8] E. G. Janardan, F. Gajendran, and P. M. S. Nambisan, "State Feedback Using Artificial Neural Network for Speed Control of DC Motor", Proceedings of the 1996 Int. Conf. on Power Electronics, Drives and Energy Systems for Ind. Growth, 8-11 January 1996, Vol. 2, pp. 753-756.
- [9] D. H. Rao and H. V. Kamat, "A Neuro-PID Speed Controller for DC Drives", Proceedings of the 1996 Int. Conf. on Power Electronics, Drives and Energy Systems for Ind. Growth, 8-11 January 1996, Vol. 2, pp. 757-763.
- [10] J. H. Horng, "Neural Adaptive Tracking Control of a DC Motor," Information Sciences, 1-4 Sept. 1999, Vol. 118, No. 1-4, pp. 1-13.
- [11] M. George, "Speed Control of Separately Excited DC Motor", American J. of Applied Sciences, Vol. 5, No. 3, 2008, pp. 227-233.
- [12] G. H. Hwang, H. J. Hwang, D. W. Kim, and J. H. Park, "A Fuzzy Logic Controller for Speed Control of a DC Series Motor Using an Adaptive Evolutionary Computation", Transaction on Control, Automation and

- Systems Engineering, Vol. 2, No. 1, March 2000, pp. 13-18.
- [13] G. M. Rao, and B. V. S. Ram, “Speed Control of Multi Level Inverter Designed DC Series Motor with Neuro-Fuzzy Controllers”, J. of Computing, Vol. 1, No. 1, December 2009, pp. 179-186.
- [14] Y. W. Lee, “A Study on the Design of Speed Controller for Induction Motor Using Tabu Search Algorithm”, KORUS’2005, 2005, pp. 818-821.
- [15] C. Elmas, and T. Yigit, “Genetic PI Controller for a Switched Reluctance Motor Drive”, Int. XII. Turkish Symposium on Artificial Intelligence and Neural Networks – TAINN 2003, pp. 1-10.
- [16] J. Kennedy and R. Eberhart, “Particle Swarm Optimization”, Proceedings of IEEE Int. Conference on Neural Networks, 1995, pp. 1942-1948.
- [17] T. V. Mahendiran, K. Thanushkodi, and P. Thangam, “Speed Control of Switched Reluctance Motor using New Hybrid Particle Swarm Optimization”, J. of Computer Science, Vol. 8, No. 9, 2012, pp. 1473-1477.
- [18] A. S. Oshaba, and E. S. Ali, “Speed Control of Induction Motor Fed from Wind Turbine via Particle Swarm Optimization Based PI Controller”, Research Journal of Applied Sciences, Engineering and Technology, Vol. 5, No. 18, May 2013, pp. 4594-4606.
- [19] A. S. Oshaba, and E. S. Ali, “Swarming Speed Control for DC Permanent Magnet Motor Drive via Pulse Width Modulation Technique and DC/DC Converter”, Research Journal of Applied Sciences, Engineering and Technology, Vol. 5, No. 18, May 2013, pp. 4576-4583.
- [20] D. P. Rini, S. M. Shamsuddin, and S. S. Yuhani, “Particle Swarm Optimization: Technique, System and Challenges”, Int. J. of Computer Applications, Vol. 14, No. 1, January 2011, pp. 19-27.
- [21] V. Selvi, and R. Umarani, “Comparative Analysis of Ant Colony and Particle Swarm Optimization Techniques”, Int. J. of Computer Applications, Vol. 5, No. 4, August 2010, pp. 1-6.
- [22] K. M. Passino, “Biomimicry of Bacterial Foraging for Distributed Optimization and Control”, IEEE. Control System Magazine, Vol. 22, No. 3, June 2002, pp. 52-67.
- [23] S. Mishra, “A Hybrid Least Square Fuzzy Bacteria Foraging Strategy for Harmonic Estimation”, IEEE Trans. Evolutionary Computer, Vol. 9, No.1, February 2005, pp. 61-73.
- [24] D. B. Fogel, “Evolutionary Computation towards a New Philosophy of Machine Intelligence”, IEEE, New York, 1995.
- [25] S. M. Abd-Elazim, and E. S. Ali, “Synergy of Particle Swarm Optimization and Bacterial Foraging for TCSC Damping Controller Design”, Int. J. of WSEAS Transactions on Power Systems, Vol. 8, No. 2, April 2013, pp. 74-84.
- [26] E. S. Ali, S. M. Abd-Elazim, “Power System Stability Enhancement via Bacteria Foraging Optimization Algorithm”, Int. Arabian J. for Science and Engineering (AJSE), Vol. 38, No. 3, March 2013, pp. 599-611.
- [27] E. S. Ali, and S. M. Abd-Elazim, “BFOA based Design of PID Controller for Two Area Load Frequency Control with Nonlinearities”, Int. J. of Electrical Power and Energy Systems, Vol. 51, October 2013, pp. 224-231.
- [28] E. S. Ali, and S. M. Abd-Elazim, “Stability Enhancement of Multimachine Power System via New Coordinated Design of PSSs and SVC”, Int. J. of WSEAS Transactions on Systems, Vol. 13, 2014, pp. 345- 356.
- [29] A. S. Oshaba, and E. S. Ali, “Bacteria Foraging: A New Technique for Speed Control of DC Series Motor Supplied by Photovoltaic System”, Int. J. of WSEAS Transactions on Power Systems, Vol. 9, 2014, pp. 185-195.
- [30] X. S. Yang, “Nature-inspired Metaheuristic Algorithms”, second edition, Luniver Press, 2010.
- [31] X. S. Yang, “Firefly Algorithms for Multimodal Optimization”, in Proceedings of the Stochastic Algorithms: Foundations and Applications (SAGA '09), Vol. 5792 of Lecture Notes in Computing Sciences, Springer, Sapporo, Japan, October 2009, pp. 178–178.
- [32] X. S. Yang, “Firefly Algorithm, Stochastic Test Functions and Design Optimization”, International Journal of Bio-Inspired Computation, Vol. 2, No. 2, 2010, pp.78–84.
- [33] G. Chandrakala, V. Ramakrishna and J. B. Shaik, “Solving Economic Dispatch with Valve Point Loading Effects by Using Optimization Techniques”, Int. J. of Engineering Science Invention, Vol. 3, No. 9, September 2014, pp.1-11.
- [34] V. Sreelekha and R. Scaria, “Firefly Algorithm Based Power Economic Dispatch of Generators Using Valve Point Effects and Multiple Fuel Options”, Int. J. of Engineering and Innovative

- Technology, Vol. 3, No. 1, July 2013, pp. 251-256.
- [35] N. S. Kumar, V. Sadasivam, and M. Muruganandam, "A Low Cost Four quadrant Chopper Fed Embedded DC Drive Using Fuzzy Controller", Int. J. of Electric Power Components and Systems, Vol. 35, No. 8, August 2007, pp. 907 - 920.
- [36] H. L. Tan, N. A. Rahim, and W. P. Hew, "A Dynamic Input Membership Scheme for a Fuzzy Logic DC Motor Controller", IEEE Int. Conf. on Fuzzy Systems, Vol. 1, 25-28 May 2003, pp. 426 - 429.
- [37] P. Z. Lin, C. F. Hsu, T. T. Lee, "Type -2 Fuzzy Logic Controller Design for Buck DC-DC Converters", Proceedings of the IEEE Int. Conf. on Fuzzy systems, 2005, pp. 365- 370.
- [38] A. E. El-kholy, and A. M. Dabroom, "Adaptive Fuzzy Logic Controllers for DC Drives: A Survey of the State of the Art", J. of Electrical Systems 2-3, 2006, pp.116-145.
- [39] J. Majed, C. Houda, J. Housseem and B. B. Naceur, "Fuzzy Logic Parameter Estimation of an Electrical System", Systems, Signals and Devices, IEEE SSD 2008, 5th Int. Multi-Conf. on 20-22 July 2008, pp. 1- 6.
- [40] B. K. Bose, "Modern Power Electronics and AC Drives", New Jersey: Prentice-Hall, 2002.
- [41] K. J. Astrom and T. Hagglund, "PID Controllers: Theory, Design and Tuning", Research Triangle Park, North Carolina: Instrument Society of America, 2nd Edition, 1995.
- [42] J. G. Ziegler and N. B. Nichols and N. Y. Rochester, "Optimum Settings for Automatic Controllers", Transactions of the ASME, Vol. 64, 1942, pp. 759-768.
- [43] J. H. Holland, "Adaptation in Natural and Artificial Systems", the University of Michigan Press, 1975.
- [44] D. E. Goldberg, "Genetic Algorithms in Search, Optimization and Machine Learning", Addison-Wesley, 1989.
- [45] A. Ashlock, "Evolutionary Computation for Modelling and Optimization", Springer, 2006.
- [46] E. S. Ali, "Optimization of Power System Stabilizers Using BAT Search Algorithm", Int. J. of Electrical Power and Energy Systems, Vol. 61, October 2014, pp. 683-690.