

Modeling of the Thermal Processes in Repository of the Waste Nuclear Fuel with Water for Assessment of Potentially Hazardous Situations

KAZACHKOV I.V.^{1,2}, KAMAEV Yu.M.¹, KHUTORNYI V.M.¹ and TOMYAK R.Ya^{1,3}

¹Dept of Heat and Power

National Technical University of Ukraine "KPI"

Polytekhnichna, 37, 03056, Kyiv

²Dept of Information Technologies and Data Analysis

Nizhyn Mykola Gogol State University

16600, Grafts'ka str. 2, Chernihiv region

³IC Consulente Ukraine, Kyiv, romekk777@gmail.com

UKRAINE

Ivan.Kazachkov@energy.kth.se kazachkov.iv@ndu.edu.ua

Abstract: - The thermal-hydraulic processes in the storage of spent nuclear fuel (SNF), which includes a pool of water for storing canisters with spent fuel assemblies (SFA) filled with water, for reliable and safe operation of such storage facilities were modeled and simulated. Mathematical model of the processes was considered, computer programs in the FLEX PDE and SOLIDWORKS platforms were developed, and the results of computational experiments were presented. Analysis of the obtained data may be useful for optimizing the parameters of the technical system under consideration and for determining the critical conditions by water loss in the pool, in the canister or in the basin and in the canister at the same time, which must be taken into account when building the storage systems for SNF and analyzing the potential emergency modes.

Key-Words: - Thermal-Hydraulic, Storage, Spent Fuel, Heat Generation, Modeling, Computer Simulation

1 Introduction to the Problem

The problem of estimating the temperature of the shells of the fuel elements (TVEL) in the spent nuclear fuel storage facility (SNFSF) under the conditions of normal operation, as well as in the design accidents, is relevant to the nuclear power industry in connection with the necessity of constructing and safe operation of such objects.

On a basis of analysis of the thermal hydraulic modes of SNFSF, it is necessary to conduct a comparative assessment of the temperature of the shells of TVEL and the conditions of not exceeding its maximum allowable values for storage under different schemes: for conditions of normal operation, in violation of conditions of normal operation and in emergency situations.

For this purpose, the calculation of the thermal load on the TVEL shells was performed at the maximum loading under different conditions of normal operation and in emergency situations, as well as an analysis of the thermal load on the TVEL shell when the use of the compressed storage scheme of nuclear fuel in storage compartments of the SNFSF was performed. When performing the work, documents and materials were used and taken into account [1-10].

In the calculation, data was used for SNFSF, with a maturity of at least 5 years, in which the maximum residual heat dissipation is 108 W at the fuel assembly with a coefficient of unevenness of the length of TVELs 1.08 and 1.2 [8]. Within the framework of this work:

- Development of the physical and mathematical model of thermohydraulic processes in the storage system and calculation of the temperature of the shells of TVEL RBMK-1000 at storage in SNFSF for several storage schemes under normal operating conditions.
- Calculation of temperature of shells of TVEL during storage in case of violation of normal operating conditions (lack of water in the storage compartments - the canisters with TVEL is filled with water, lack of water in the canisters - the storage compartments of SNFSF are filled with water, lack of water in the compartments and in the canisters).
- Calculation of temperature of shells of TVEL at storage in pool compartments of the SNFSF for various compressed storage schemes, under normal operating conditions and in case of violation.

- Analysis of the results and conclusions about their practical use for SNFSF.

A group of canisters and their location in the catchment pool are shown in Fig. 1, from which it is clear that the distance between the canisters in the row is much less than the distance between them in the adjacent rows, so the most thermo-stressed place will be between the canisters in each row, given that the convective flow in the cracks between the canisters in the row will be much weaker than that in the space between the rows.

In addition, the flow regime in the crevices in a significant range of heating modes is laminar, and between the rows is turbulent. In the latter case, the coefficient of heat transfer is several orders of magnitude higher, therefore the intensity of heat transfer is much higher.

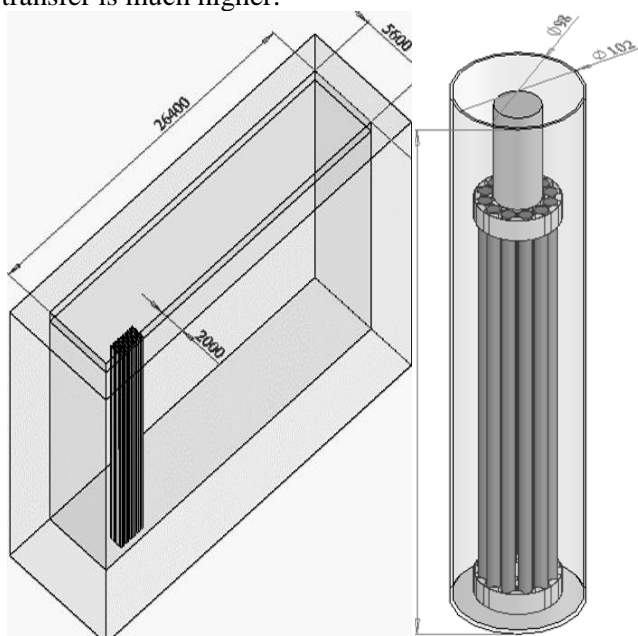

Fig. 1 Scheme of pool with a group of canisters and view of the TVELs in shells inside a canister (in mm)

Due to the symmetry of the system only one of its elements can be considered in the calculations, which includes a group of several canisters. In the rest of the area, the picture is identical. If heterogeneity of the residual heat dissipation of the TVEL in height is not taken into account, then in each horizontal section, the convective flow is possible only due to the above heterogeneity of heat transfer in the space between the individual canisters in a row and in the space between the rows of canisters. In a small area between the canisters in one row the convective flow is weaker and there is the maximum local thermal stress. The temperature field in the main part, between rows, is aligned most rapidly due to intense heat transfer because of turbulent flow between rows of canisters.

The turbulent flow is set there quite quickly, which is confirmed by the large Reynolds numbers due to the large characteristic dimensions of the area. Even relatively small velocities of the thermal convective flow can lead to the large Reynolds numbers.

The main criterion is the Rayleigh number determining the convective flow regime. Moreover, the important factor of the convective flow in a region is heterogeneity of the heat release in the height of canisters as far as the upper part of the canister has no internal heat generation, even in homogeneous heating by height of each TVEL and its shell. This is because as shown in Fig. 1 the TVEL is shorter than canister, where it is placed inside.

2 Statement of Mathematical Modeling of the System

2.1 The Governing Equations of the Model

The constitute equations of the mathematical model express the conservation of the mass, momentum and energy for water, air, the walls of canisters and pool, TVEL. In cylindrical coordinate system (r, ϕ, z) , where $r = const$ is coordinate surface, $\phi = const$ is semi plane and $z = const$ is plane, the governing equations are written in the following form [11,12]:

$$\begin{aligned} \frac{\partial u}{\partial r} + \frac{u}{r} + \frac{1}{r} \frac{\partial v}{\partial \phi} + \frac{\partial w}{\partial z} &= 0, \\ \frac{\partial T}{\partial t} + u \frac{\partial T}{\partial r} + \frac{v}{r} \frac{\partial T}{\partial \phi} + w \frac{\partial T}{\partial z} &= \\ &= a \left[\frac{\partial^2 T}{\partial r^2} + \frac{1}{r^2} \frac{\partial^2 T}{\partial \phi^2} + \frac{\partial^2 T}{\partial z^2} + \frac{1}{r} \frac{\partial T}{\partial r} \right], \quad (1) \\ \frac{\partial u}{\partial t} + u \frac{\partial u}{\partial r} + \frac{v}{r} \frac{\partial u}{\partial \phi} + w \frac{\partial u}{\partial z} - \frac{v^2}{r} + \frac{1}{\rho} \frac{\partial p}{\partial r} &= \\ = v \left[\frac{1}{r^2} \frac{\partial u^2}{\partial \phi^2} + \frac{\partial^2 u}{\partial r^2} + \frac{1}{r} \frac{\partial u}{\partial r} + \frac{\partial^2 u}{\partial z^2} - \frac{2}{r^2} \frac{\partial v}{\partial \phi} - \frac{u}{r^2} \right], \\ \frac{\partial v}{\partial t} + u \frac{\partial v}{\partial r} + \frac{v}{r} \frac{\partial v}{\partial \phi} + w \frac{\partial v}{\partial z} + \frac{uv}{r} + \frac{1}{r\rho} \frac{\partial p}{\partial \phi} &= \\ = v \left[\frac{1}{r^2} \frac{\partial v^2}{\partial \phi^2} + \frac{\partial^2 v}{\partial r^2} + \frac{1}{r} \frac{\partial v}{\partial r} + \frac{\partial^2 v}{\partial z^2} + \frac{2}{r^2} \frac{\partial u}{\partial \phi} - \frac{v}{r^2} \right], \\ \frac{\partial w}{\partial t} + u \frac{\partial w}{\partial r} + \frac{v}{r} \frac{\partial w}{\partial \phi} + w \frac{\partial w}{\partial z} + \frac{1}{\rho} \frac{\partial p}{\partial z} &= \\ = v \left[\frac{1}{r^2} \frac{\partial w^2}{\partial \phi^2} + \frac{\partial^2 w}{\partial r^2} + \frac{1}{r} \frac{\partial w}{\partial r} + \frac{\partial^2 w}{\partial z^2} + g\beta_T \Delta T \right]. \end{aligned}$$

For the solid media the only one heat conductivity equation is considered

$$\frac{\partial T}{\partial t} = a \left[\frac{\partial^2 T}{\partial r^2} + \frac{1}{r^2} \frac{\partial^2 T}{\partial \phi^2} + \frac{\partial^2 T}{\partial z^2} + \frac{1}{r} \frac{\partial T}{\partial r} \right] + \frac{1}{\rho} \left(\frac{\partial q_r}{\partial r} + \frac{q_r}{r} + \frac{1}{r} \frac{\partial q_\phi}{\partial \phi} + \frac{\partial q_z}{\partial z} \right), \quad (2)$$

where the last term has concern only for the TVEL, the other media do not generate the heat. Here u, v, w - the velocity components, μ - dynamic viscosity coefficient, q - vector of the internal heat generation, g - acceleration due to gravity, β_T - thermal expansion coefficient, $\Delta T = T - T_0$ - local temperature difference in the system, T_0 - given temperature. The thermal convection is determined by the Prandtl number $Pr = \nu / a$ and Rayleigh number $Ra = V_b^2 H^2 / (\nu \cdot a)$, where H is the scale of the system (height of the canister), ν - kinematic viscosity coefficient, a - coefficient of heat diffusivity, $V_b = g \beta_T \Delta T H$ - characteristic rate of the convective heat flux.

2.1.1 Simplification of the Model

Due to small flow velocity by thermal convection, the nonlinear convective terms of the second order are neglected in the momentum equations keeping the inertial, viscous and thermal convective terms:

$$\begin{aligned} & \frac{\partial T}{\partial t} + u \frac{\partial T}{\partial r} + \frac{v}{r} \frac{\partial T}{\partial \phi} + w \frac{\partial T}{\partial z} = \\ & = a \left[\frac{\partial^2 T}{\partial r^2} + \frac{1}{r^2} \frac{\partial^2 T}{\partial \phi^2} + \frac{\partial^2 T}{\partial z^2} + \frac{1}{r} \frac{\partial T}{\partial r} \right], \quad (3) \\ & \frac{\partial u}{\partial r} + \frac{u}{r} + \frac{1}{r} \frac{\partial v}{\partial \phi} + \frac{\partial w}{\partial z} = 0, \quad \frac{\partial u}{\partial t} + \frac{1}{\rho} \frac{\partial p}{\partial r} = \\ & = \nu \left[\frac{1}{r^2} \frac{\partial u^2}{\partial \phi^2} + \frac{\partial^2 u}{\partial r^2} + \frac{1}{r} \frac{\partial u}{\partial r} + \frac{\partial^2 u}{\partial z^2} - \frac{2}{r^2} \frac{\partial v}{\partial \phi} - \frac{u}{r^2} \right], \\ & \frac{\partial v}{\partial t} + \frac{1}{r \rho} \frac{\partial p}{\partial \phi} = \nu \left[\frac{1}{r^2} \frac{\partial v^2}{\partial \phi^2} + \frac{\partial^2 v}{\partial r^2} + \frac{1}{r} \frac{\partial v}{\partial r} + \frac{\partial^2 v}{\partial z^2} + \frac{2}{r^2} \frac{\partial u}{\partial \phi} - \frac{v}{r^2} \right], \\ & \frac{\partial w}{\partial t} + \frac{1}{\rho} \frac{\partial p}{\partial z} = \nu \left[\frac{1}{r^2} \frac{\partial w^2}{\partial \phi^2} + \frac{\partial^2 w}{\partial r^2} + \frac{1}{r} \frac{\partial w}{\partial r} + \frac{\partial^2 w}{\partial z^2} + g \beta_T \Delta T \right]. \end{aligned}$$

The equation array (3) present the mathematical model for the thermal hydraulic processes studied in this paper.

2.1.2 Distributed Internal Heat Generation

The distributed internal heat generation is accounted from internal heat generation. Heat conductivity in the shell of canister is modeled by linear velocity profile with an angle of inclination determined by the conductivity of the wall material.

2.2 Boundary Conditions

Boundary conditions on the surface of the fuel rods are stated of the second type (heat transfer in the gap between the surface of fuel rod and shell of the canister): $\partial T / \partial r = \alpha_f (T_{fw} - T_s)$, where α_f - heat transfer coefficient from fuel to water, T_{fw} - temperature of fuel rod on surface, T_s - temperature of surrounding water.

On the inner surface of the wall of the canister, the boundary condition of the fourth kind (conjugate boundary value problem) is stated. The heat fluxes from the liquid in the gap are equal to the heat flowing into the wall of the canister:

$$\kappa_s \partial T_s / \partial r = \alpha_c (T_{cw} - T_s),$$

where κ_s is heat conductivity of water, α_c - heat transfer coefficient from canister to water, T_{cw} - temperature of the canister wall.

When solving the problem of convective flow in the gap of canister on the walls and the usual conditions of zero velocity are stated on the surface of the TVEL for the field velocities. Similarly - for the flow and heat exchange in the catchment pool (CP). And the same conditions are implemented on the surfaces of the pool and canister (outside).

The boundary conditions of the fourth kind (conjugate boundary value problem) are considered for the temperature on both surfaces. In the CP wall, the temperature profile is linear and outside of it the boundary condition of the first kind is considered for simplicity. In a more general case, the boundary condition of heat exchange with the surrounding atmosphere must be stated at the outer surface of the walls as well.

In this formulation, calculations on the computer are significantly simplified, with the known temperature of the CP wall and the known intensity of the internal heat generation. This significantly reduces the number of iterations in the numerical solution of the boundary problems.

3 Computer Modeling of the Processes

The simplest codes like the module HEATING 7.2 of the computer code SCALE 4.4 [13] can be used for the boundary problems stated above. The stated connections among the described elements of the system may use the equivalent heat conductivity coefficients accounting the air heat conductivity and the heat transfer due to natural convection and radiation.

However, this code is somewhat outdated, so we used SOLIDWORKS, FLOWWORKS allowed

solving the problems in a complex way - from building a three-dimensional physical model with the above-described visualization of the system to the thermodynamic calculations in it and further visualization of the results.

Some of the tasks were solved using the FLEX PDE system - the software platform of the Wolfram Research Institute (USA), which allows the user to write computer programs for solving the boundary value problems for partial differential equations. The abbreviation for this platform means "a flexible tool for solving partial differential equations". The tool is powerful using the method of triangulation and automatic adaptation of the finite element grid at each step in each node of the calculated area.

The accuracy of the numerical solution of the boundary problem is regulated and the entire course of the problem is detailed on the screen, so that an experienced specialist in numerical solution of the boundary problems can control it operatively. A great GUI and rich graphing capabilities make it easier to write a report based on computations.

3.1 Data for Computational Experiments

In accordance with the above methodology for simulation of the thermal-hydraulic processes, the computational experiments on the PC were performed using the developed mathematical models of processes during storage of SNF in the water pool.

Nonlinearities of thermophysical properties, in particular, the dependence of the coefficient of thermal conductivity on temperature, can cause various anomalous phenomena, e.g. local abnormal temperature increase in narrow areas [14-16].

3.1.1 Physical Properties of the Materials

The main thermophysical properties of materials used in the calculations carried out in this paper are presented in the tables below [17, 18]. Thermal properties of materials are introduced using the maps 201MMMNN.

Thermal properties of nuclear fuel (UO_2) are given in Table 1 in accordance with [17, p.9.1]:

Table 1 Dependence of thermal conductivity and heat capacity of nuclear fuel (UO_2) on temperature

Temperature K	Heat conductivity W/(m·K)	Heat capacity kJ/(m ³ ·K)
300	8.15	2849
500	6.70	3014
700	5.40	3153

where it can be seen that the dependence of the thermal conductivity and the heat capacity of nuclear fuel on temperature is significant only in the wide

range of temperature changes from 300K to 700K. But these dependencies are relatively small in our range of temperature changes, and reliable data in the literature was not found. Therefore, the given physical properties are supposed constant in the first approximation.

Table 2 Dependence of thermal conductivity and heat capacity of the TVEL shell on temperature

Temperature K	Heat conductivity W/(m·K)	Temperature K	Heat capacity kJ/(m ³ ·K)
293.15	17.2	293.15	1768
373.15	18.0	373.15	1831
473.15	19.3	500	2069
573.15	20.1	600	2169
673.15	20.5	700	2268

Table 3 Dependence of thermal conductivity and heat capacity of steel 10ГН2МФА on temperature

Temperature K	Heat conductivity W/(m·K)	Heat capacity kJ/(m ³ ·K)
293.15	26.75	3.0537E+6
373.15	32.53	3.4462E+6
473.15	39.76	3.9407E+6
573.15	46.98	4.4353E+6
673.15	54.20	4.9298E+6

Table 4 Dependence of thermal conductivity and heat capacity of steel 12X18H10T on temperature

Temperature K	Heat conductivity W/(m·K)	Heat capacity kJ/(m ³ ·K)
293.15	15.0	3.6498E+6
373.15	16.0	3.8986E+6
473.15	18.0	4.0429E+6
573.15	19.0	4.1856E+6
673.15	21.0	4.2570E+6

3.1.2 Peculiarities of the Thermal Properties

Thermal properties of the material of the shell TVEL (alloy E-110) are given in Table 2 [17, p.9.1]. Heat capacity is calculated according to data of OKB Hydropres, Rivne NPP, power unit 2, Technical justification of NPP safety, Suppl. 2.

As it follows from the data review Table 2, the dependence of the thermal conductivity and the heat capacity of the material of the TVEL shell on the temperature is also very small. In the first approximation it is possible here to assume these properties as constant, or to approximate them with linear dependences on temperature.

Thermal properties of 10HN2MFA steel are given in Table 3 [17, p.9.2]. The thermal properties of steel 12X18H10T data in Table 4 [17, p.9.2]. Obviously, in all of the physical properties of the media in the range of temperatures under consideration, their dependence on temperature can be considered as linear functions in the first approximation or even accepted as constant.

3.2 Computational Experiments in FLEX PDE

The developed program in the FLEX PDE platform of the Wolfram Research Institute [19] was used to calculate the parameters of the thermal state in the storage of wasted nuclear fuel with water. The program is designed from a simple heat conduction problem for a circular area, which is repeated on different scales: a rod, a cassette, a case. The properties of substances in the regions, their radii and location are devasted. It can be useful for the specified kind of calculations.

3.2.1 Computer Simulation for 9 Canisters

The calculation of a fragment of a system of 9 canisters in the basin was carried out for a case where the environmental impact is more significant than in the case of dense filling (Fig. 2).

Such calculation of the thermal hydraulic processes and the temperature of the shells of TVEL SFA RBMK-1000 during storage in the repository for the existing storage scheme shows that the group of canisters is surrounded by approximately symmetrical external convective flow, in which the temperature practically does not change for 4 million seconds (approximately 46 days).

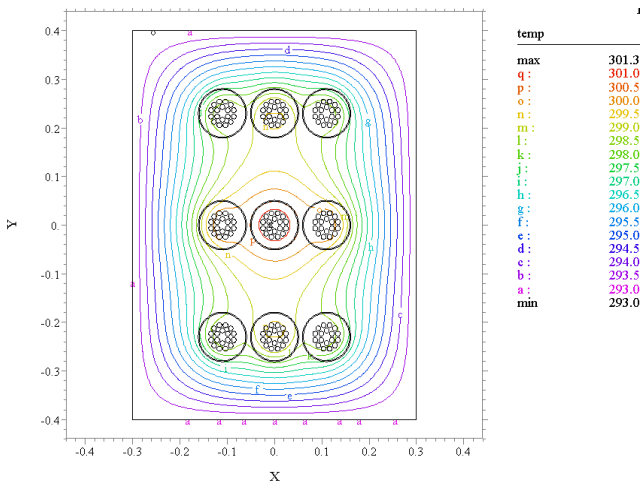

Fig. 2 Calculation of the temperature (K) fields for the group of canisters for time interval 40 days

In the water layer, the temperature changes only a few degrees. The total temperature difference in the system reaches about 8.3 degrees, and in the SFA temperature is only 3 degrees higher than the water temperature in the canister. In the central canister, as it is located in the place of the least weak convective motion, the temperature of the SFA is greatest (28.3 °C), while in other canisters, the temperature in the center of the SFA is several degrees lower. The temperature on the graphs is shown on the Kelvin scale. In analysis of the results the temperature on the Celsius scale is used everywhere as more convenient.

3.2.2 Computer Simulation for 36 Canisters

Fig. 3 shows the calculation for a longer time interval (2 months) for the case of a group of 36 canisters. In the center of the region, the highest temperature of the SFA reaches 50 degrees, the water temperature in the canister varies from 50 to 40 °C approximately, and in the main part of the basin, the water temperature varies from 30 to 20 °C on the wall, which is cooled by the environment with a constant temperature 20 °C.

If we take into account that the environment sometimes has a higher temperature and air is practically immobile, then the coefficient of heat transfer from the outer surface of the basin wall is low and then the wall will gradually warm up, and the temperature in the pool and canisters will grow more intensively. Thus, calculation for the case of heat transfer conditions on the inner and outer walls of the pool shows in Fig. 4.

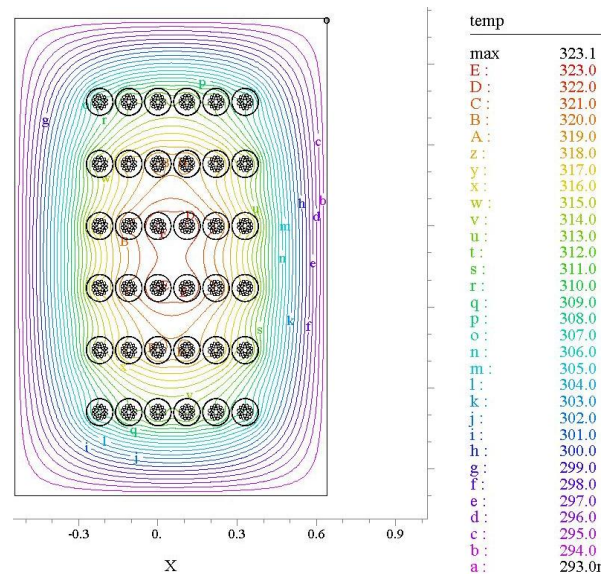

Fig. 3 Calculation of the temperature (K) fields for the group of canisters for time interval 2 months

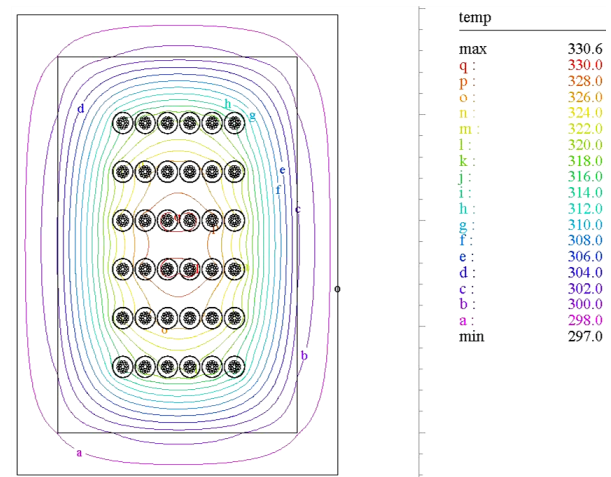

Fig. 4 Temperature (K) under heat transfer on walls

The condition of heat transfer from the water in the pool to the wall is on the inner wall, and on the outside - the heat transfer from the wall of the pool to the environment with a temperature of 20 °C.

The temperature distribution over time is less than that of Fig. 3 (40 days against 2 months), shows that in the system, taking into account the heat transfer conditions on the inner and outer walls of the basin, the temperature rise slightly more intense. The temperature of the inner wall of the pool reaches 27-30 °C, and the outside in some places grows to 25 °C. At the same time, the temperature of the SFA grows to 57 °C in 40 days versus 60 days in the preceding case. Though not critical, but more significant growth.

3.2.3 Estimation of temperature during normal operation and in case of violation of regime

The first violation of the regime to be considered is the lack of water in the canisters. Then, as shown in Fig. 5, under the same situation in the basin, which is considered in Fig. 3, and under the same conditions of holding the wall of the pool at 20 °C of the environment, the temperature of the SFA and water in the basin in 2 months grows more: SFA reaches 70 °C, close to the temperature of air in the canisters, and the water temperature in the pool in some places grows to 40 °C, in the main part it is below this level.

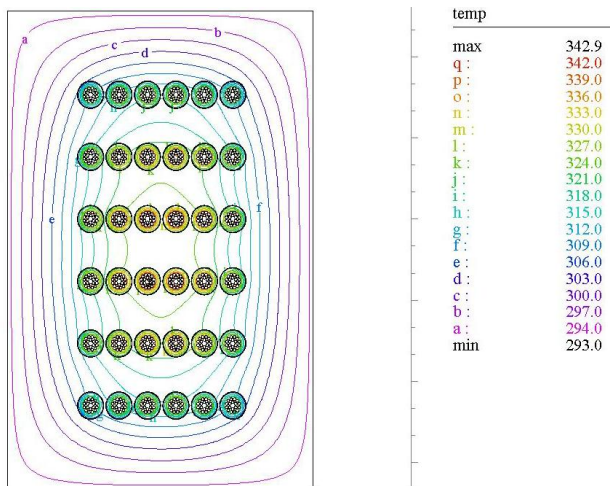

Fig. 5 Temperature (K) in group of canisters after 2 months in absence of water in canisters

If there is no water in the pool, and there is water in canisters, then nearly the same heating of the system is achieved in about 10 days like in the two months in the previous case. Fig. 6 shows that the maximum temperature in the SFA in 10 days reaches 80 °C, while the water in the pool is heated in separate places more than 60 degrees, but the water temperature is from 60 °C near canisters up to 20 °C on the walls of the pool.

In 14 days, this situation develops in such a way that the temperature of the SFA reaches 100 °C (Fig. 7), and the water temperature in some basin areas reaches 80 °C (in places of maximum concentration of heat dissipation SFA).

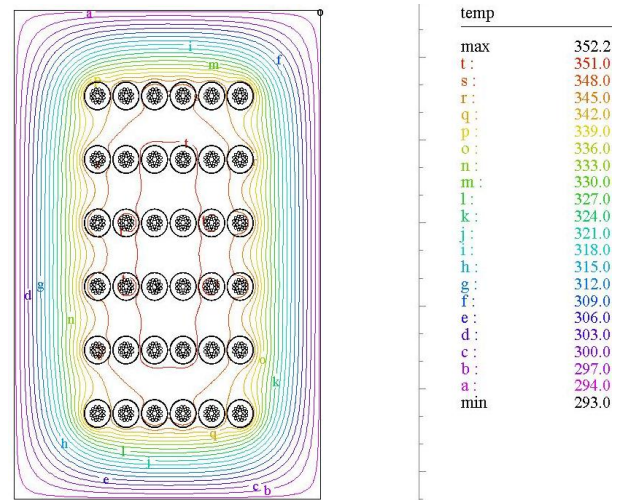

Fig. 6 Temperature (K) field after 10 days in absence of water in the pool (there is water in canisters)

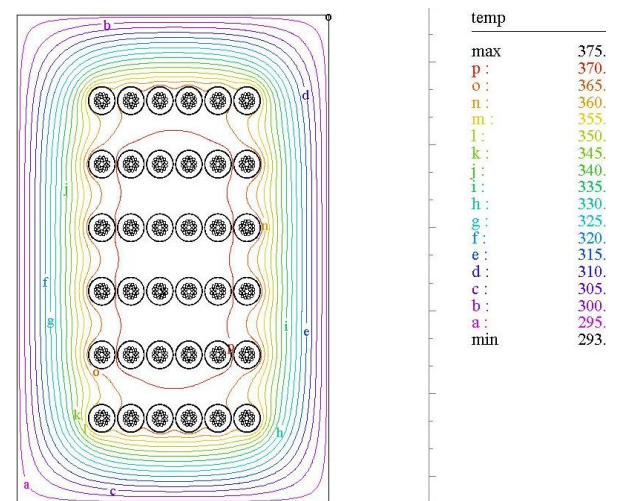

Fig. 7 Temperature (K) field after 14 days in absence of water in the pool (there is water in canisters)

Thus, this model is not applicable as soon as a boiling starts in the pool, after reaching the water 100 °C temperature. But there will be no big errors in assessment of temperature in the system, because the heat of vaporization is about the same as the heat consumed on water heating from 20 to 100 °C.

3.3 Computation in SOLID WORKS

Due to absence of the two-phase model in the FLEX PDE for the moment, we adopted the SOLID WORKS for the numerical simulation of the total process including the boiling regime.

After the start of boiling in the pool, there will be no water but the steam-water mixture, which leads to a sharp decrease in the heat transfer coefficient, especially in the crisis of heat transfer. In such a situation, more intense SFA heating can be observed. But the canisters with SFA have a connection with the atmosphere in the upper part, therefore, due to intensive convective heat exchange with the environment; the significant thermal unloading is carried out through the open top of the canisters.

Figures 8, 9 show the situation of the convective heat transfer through the upper surface of the canisters contacting with atmosphere. The average daily temperature of atmosphere is below the 20 °C for long time intervals.

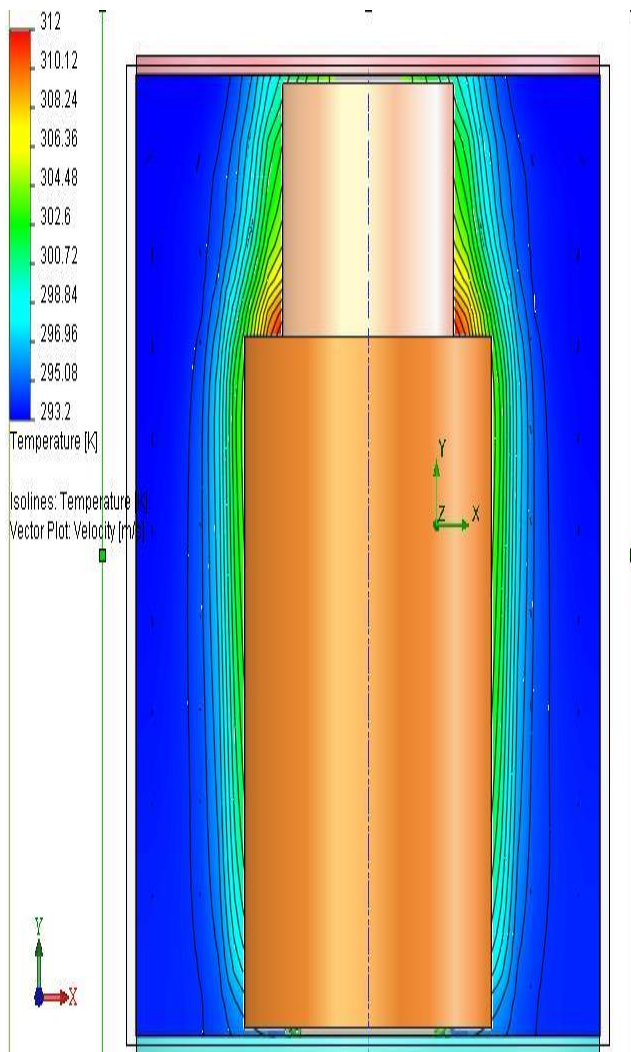

Fig. 8 Picture of convective heat transfer of air in the canisters without water

The temperature field in 2 months in the absence of water in the pool (there is water in canisters) is presented in Fig. 10. But these data are not very reliable, because the water in the canisters evaporates after 100 °C. Thus, when the temperature of 100 °C is

exceeded, the thermohydraulic pattern in the studied system is considerably more complicated.

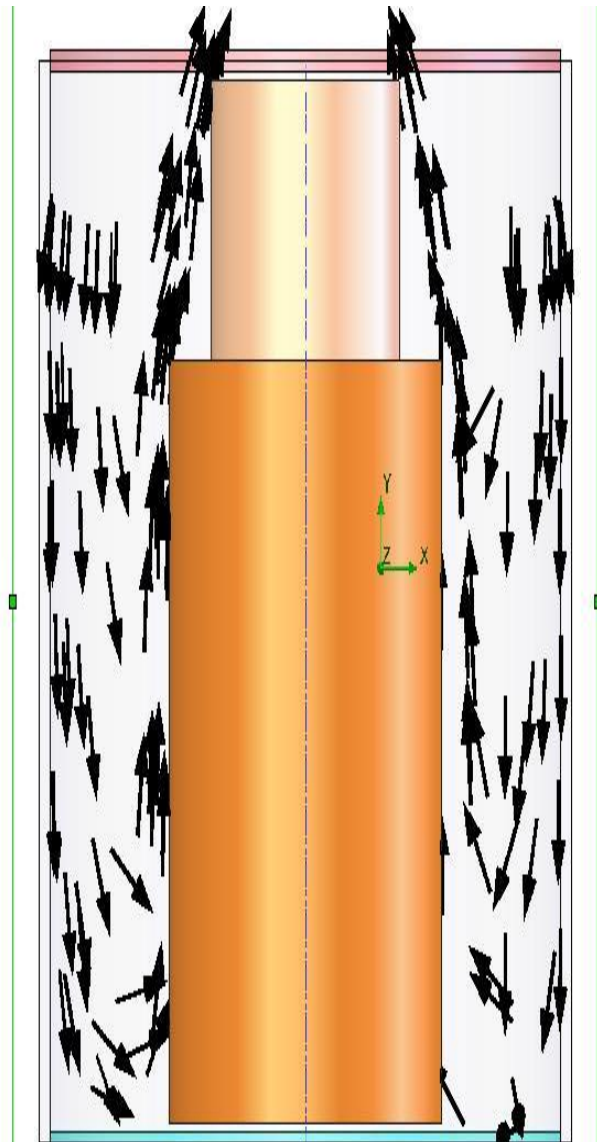

Fig. 9 Trajectories of convective heat transfer of air in the canisters without water

First, the steam phase appears and the coefficients of heat transfer from water to canisters sharply change up to the crisis of heat transfer on the surface of canisters, when the coefficients of heat transfer fall down 2-3 orders of magnitude. After the evaporation of all water in the canisters, the vapor goes into the atmosphere and air circulation begins in the canisters, exchange of heated air in the canisters with the cold air of the atmosphere.

During the transition process, when the SFA is being by cooled by a steam-water mixture, significant inhomogeneities of the SFA cooling are possible on their surface, because the steam-water flow is unstable and constantly changing due to evaporation of water. At this stage, the vapor goes in

the atmosphere and the entrance of the cold air begins from atmosphere into the canisters.

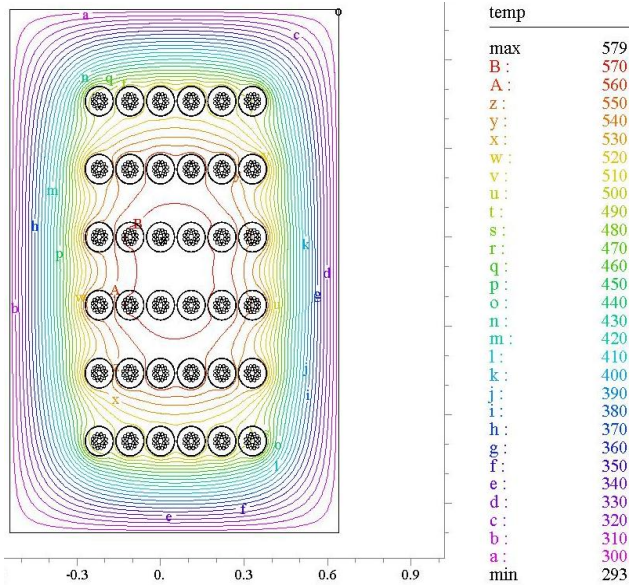

Fig. 10 Temperature (K) after 2 months in absence of water in pool (water in canisters at the beginning)

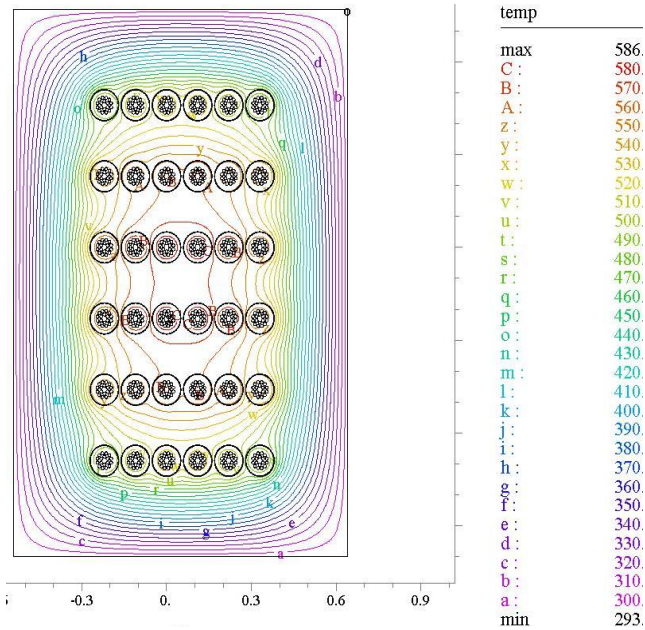

Fig. 11 Temperature (K) field after 40 days in absence of water both, in pool and in canisters

Thus, for some time there is a steam-water-air multiphase flow, which eventually changes with the air flow. Fig. 11 confirms the foregoing with respect to the regime of heat exchange in the canisters when boiling begins inside them.

Calculation of the thermal state of the system in the absence of water in the pool and canister, carried out at intervals of 40 days, shows a slightly higher temperature compared with the calculation for 2 months for the case of water in the canisters.

About two weeks goes additionally to evaporate water from the canisters, after which the thermal regimes of the system, shown in Figs 10, 11 practically do not differ. As can be seen from the data of numerical computer simulations, the compactness under normal conditions (water is in the pool and in the canisters) leads to the fact that water in most of the pool does not have time to heat up significantly.

The maximum temperature of the SFA in the canisters reaches 50 °C about 4 times faster than in the original package (Fig. 3). Fig. 12 shows how the system evolves during the same 16 days in the event of a violation of normal conditions (lack of water in the canisters). Here the difference is even stronger.

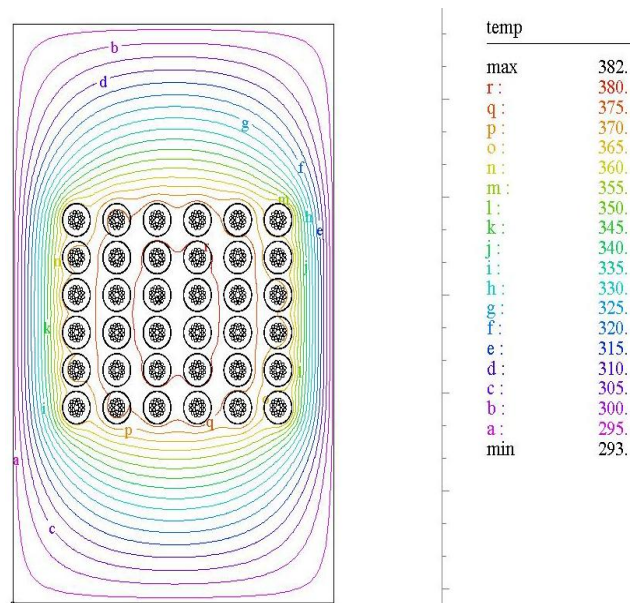

Fig. 12 Temperature (K) for compacted by 20% canisters 16 days under breaking normal conditions (water is in pool but canisters are without it)

And calculation for the case of violation of the conditions of normal operation when the water is in the pool, and in the canisters there is no water, is given in Fig. 12.

3.4 Computation in 3D FLEX PDE

Let's consider also the influence of the density of the canisters' distribution in a space of the pool on the main thermohydraulic parameters of the storage.

First, we analyze the case of consolidation by 20% by volume, occupied by canisters with spent fuel in the catchment pool. Calculation for a compacted fuel storage situation under normal operating conditions when the pool and canisters are filled with water is presented in Fig. 13 for a period of up to 16 days.

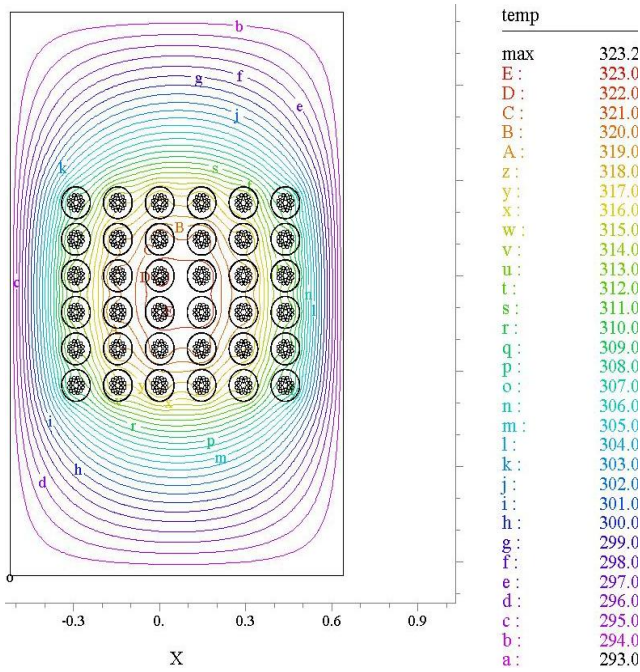

Fig. 13 Temperature (K) in pool and canisters filled with water compacted by 20% during 16 days

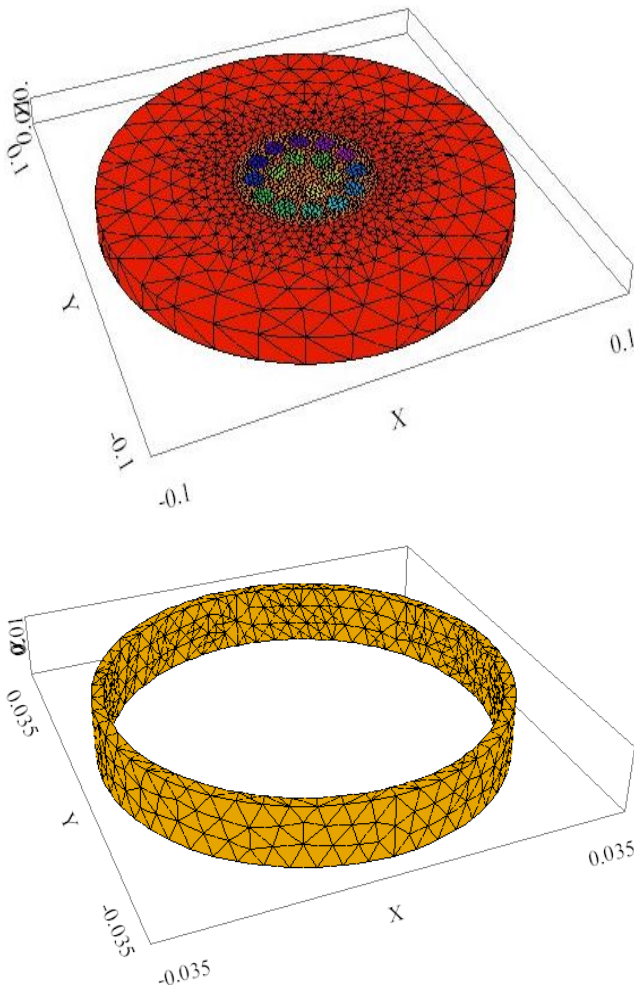

Fig. 14 The 3-D numerical grid for TVEL and for shell of TVEL (below) in the FLEX PDE

The system is compacted and there is a significant bias in the distribution of heat between the canisters and water in the pool. In a large part of the pool, the water is heated more slowly, whereas in the SFA the temperature increases more intensively.

In addition to SolidWorks, the 3-D was also addressed in the FLEX PDE. But the 3-D model requires too much memory in calculation on the PC resulting in a program quick stop. Several initial steps of such calculations of the 3-D FLEX PDE program for the thermal state of TVEL are presented in Fig.14.

Figs 15, 16 show the temperature fields of the TVEL in a shell with water and air, respectively, for the moment $t = 10^5$, from where it is visible how intensely the water is cooling SFA and how bad coolant is the air.

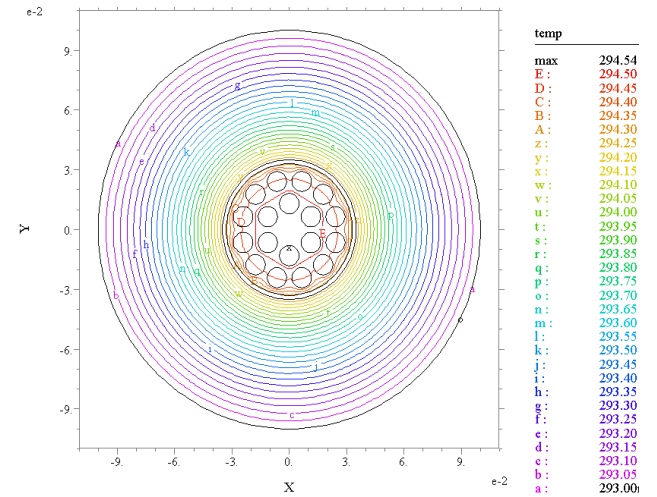

Fig. 15 Temperature (K) field for the TVEL in shell with water at the time moment $t = 10^5$

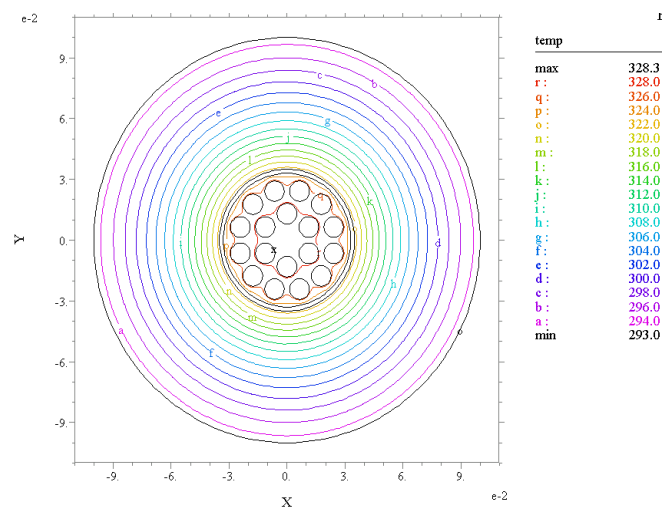

Fig. 16 Temperature (K) field for the TVEL in shell with air at the time moment $t = 10^5$

4 Conclusions

Mathematical model of the hydrodynamics and heat transfer processes of in the storage of spent nuclear fuel was constructed and computer programs developed in FLEX PDE and SolidWorks systems. They allowed performing a set of computational experiments for establishing the regularities of processes in the repository.

The variations in the distribution density of spent fuel canisters have been calculated for normal operation conditions and with their disturbances: without water in canisters, with loss of water in the catchment pool, or both. In all cases considered, critical durations were found over time, for which canisters with SFA heat up to 50, 100 and 300 °C.

Similar data were obtained from the heating of water or air in the pool and in the canisters for different occasions. It has been established that the minimum critical time is several days - depending on the situation. In the worst case, unacceptable heating of SFA or water in the pool is achieved in sufficient time to respond and eliminate faults or accidents. The data obtained can be useful to developers and exploiters of spent fuel storage facilities.

References:

- [1] DSTU 3973-2000. The system of development and production establishment. Rules for carrying out scientific research works. General terms. (In Russian).
- [2] GND 95.0.01.03.006-97. Technical assignment for carrying out scientific research, experimental design and experimental-technological works. Procedure for development, construction, approval and registration. (In Russian).
- [3] TVS RBMK-1000. Technical specification. 862.00.000 TO. (In Russian).
- [4] TVS RBMK-1000. Technical conditions. TU 95.5086-78. (In Russian).
- [5] TVS RBMK-1000. Assembling drawing. 861.01.000 SB. (In Russian).
- [6] Heat-radiating element RBMK-1000. 861.01.010. (In Russian).
- [7] Canister (Penal). Technical conditions 1.5000-3866.00.00TY. (In Russian).
- [8] Report NIKIET. Radiation characteristics of the spent fuel of the Chernobyl nuclear power plant (version 2). 2005. (In Russian).
- [9] Instruction for operation of the cooling and water treatment system of the pools of the cooling of the CHOYaT-1 workshop on the management of spent nuclear fuel, 15E-TsOOYaT. (In Russian).
- [10] General explanatory note. Chernobyl NPP, III turn. CHOYaT, I turn. Working project Collective-monolithic version. Part «a». 1983. (In Russian).
- [11] Lykov A.V. Heat&mass transfer. Reference book. – M.: Energiya, 1972. – 560 pp.
- [12] The theory of heat and mass transfer/ed. prof. A.I. Leontiev. – M.: Vysshaya shkola, 1979. – 495 pp.
- [13] HEATING 7.2 User's manual. Oak Ridge National Laboratory, 2000 – 132 p.
- [14] Kazachkov I.V. and Konovalikhin M.J. A Model of a Steam Flow through the Volumetrically Heated Particle Bed// Int. J. of Thermal Sciences.- 2002.- Vol.41, 1077-1087.
- [15] Kazachkov I.V., Konovalikhin M.J. and Sehgal B.R. Dryout Location in a Low-porosity Volumetrically Heated Particle Bed// J. of Enhanced Heat Transfer. 2001.- Vol.8, no.6, p.397-410.
- [16] Konovalikhin M.J., Kazachkov I.V. and Sehgal B.R. A model of the steam flow through the volumetrically heated saturated particle bed/ ICMF 2001: Fourth International Conference on Multiphase Flow, New Orleans, Louisiana, U.S.A., May 27 - June 1, 2001.
- [17] Project of in-depth analysis of safety of unit number 1 of Khmel'nitsky NPP. Database of data on a nuclear steam generating installation. BOA 301913-A-R4. 2001. (In Russian).
- [18] Physical values. Reference book - Moscow, Energoatomizdat, 1991.– 1232 pp.
- [19] <https://www.pdesolutions.com>