

Sustainable development education in an electronic engineer school: experimental study of thermal losses in a realistic small scale house by infrared thermal imaging

Ph. DONDON (1)- C.A. BULUCEA (2)- R. CHARLET DE SAUVAGE(3)

(1) Université de Bordeaux, IPB, Av Dr A. Schweitzer 33405 Talence, France.

(2) Faculty of electrical engineering, University of Craiova, Romania

(3) IMS, UMR 5218, ENSCBP, 16 av Pey-Berland 33607 Pessac, France

Philippe.Dondon@enseirb-matmeca.fr, abulucea@gmail.com

Abstract: This paper relates to a concrete experience of sustainable development concept introduction in an electronic engineer school. The design and realisation of a small scale genuine materials house itself (1/20 scale) and surroundings have already been exposed in a previous paper [1]. A second paper described and discussed the carbon assessment method applied to this small scale house design [2]. This new experimental paper focuses on thermal aspects, insulation efficiency, qualitative and quantitative measurements. Thermal losses of the house are located, quantified by comparative tests between different kind of windows and insulators, with temperature sensors and infrared thermal imaging. As these experiments are positive, we will transfer this 1/20 model kit for educational purpose and practical lessons in first year study as well as demonstrator for sustainable exhibition.

Key words: Infrared thermal imaging, Education to Sustainable development, cross disciplinary project,

1. Introduction

This “sustainable development” project was initialized at ENSEIRB-MATMECA school: The “Ecole Nationale Supérieure d’Electronique, Informatique et Radiocommunications de Bordeaux”. It consists of a Computer Science Department, Electronics Department, Telecommunications Department, Mathematic and mechanical Department, training in alternation Department. ENSEIRB-MATMECA is member of IPB (institute polytechnique de Bordeaux) strongly linked to the Bordeaux 1, Science and Technology University.

2. The project context

2.1 National collaboration

This global project was carried out through national collaboration with “the House of the Nature and the Environment” (MNE) of Bordeaux, national french organism ADEME (Agency of the Environment and the Control of Energy) France, the ENSEIRB-MATMECA (33400 Talence), the colleges Chambéry (33140 Villenave d'Ornon) and Henri Buisson (33400

Talence) (professors and pupils) for the realization of the small scale house.

2.2 International collaboration

Thanks to a bilateral European collaboration with Faculty of electromechanical and environment engineering (Craiova University-Romania), it was possible to establish academic connexion on sustainable development, to share the design of project.

2.3 Sustainable Development context

The necessity of sustainable development is now well admitted by most of politicians and economic specialists. Mass media speak about bio diversity, ecological human footprint and climate change almost every day [3]. Some actions have been started at the local and national scales [4]. However, progress is very slow because favour is often given to the short term goals and not to those of the long term.

Face to change necessity [5], we are often reluctant or suspicious whatever the field of change [6]. We highlights “true or false” arguments against the required changes. However, - like it is written in [7]-, a

progressive cultural change, is needed in education to embrace broad skills, environmentally aware attitudes, knowledge and fundamental values, human behaviour, as well as a sense of ethical responsibility, rather than the narrowly focussed “technical excellence” which is traditionally accepted as good engineering education definition

Taking into account this daily and classical behaviour of each of us, how to introduce step by step, the sustainable development necessity with serenity, without shocking, while inviting to a progressive for the benefit of all?

3. Action and education

3.1 Education

There is no recipe or magic formula to teach sustainable development. This is a question of common sense. However, depending of personal feelings, personal development tools or yoga art can for example help the individual evolution process to improve the level of consciousness. National educational system and family education are complementary from the youngest age.

3.2 Introducing Sustainable development in educational system

Sustainable development should not be seen as a supplementary layer and/or a supplementary workload. It just could be seen as a basement of the education. Because child’s of today are the adults of tomorrow, French education ministry already gave priority and directives to nursery and primary schools. But, secondary schools and university must also be leaders in education to sustainable development.

Thus, at primary school, pupils are now sensitized to sustainable development: good daily behaviours are discussed (i.e. to avoid wasting turn off the light when not used, be careful with the water, waste sorting, public transportation use, and so on). At secondary school, sustainable development is now included in the syllabus : In particular, teenagers work on “Agenda 21” contents, local actions in town hall, sustainable development project in their cities.

At higher education level, some actions are now starting even they are not still well structured: as the scientific knowledge of the students increase with their study level, researchers and teachers are now able to include progressively and softly sustainable

development concept in University whatever the field of study: thermal, mechanical, chemical, electronic, optical, economics and so on. Scientific, quantitative and rational aspects can be developed to complete and insure continuity with primary and secondary education.

4. Small scale House project state of art

4.1 Generalities

According to previous discussions in § 3., the project of small scale house model started three years ago thanks to an individual questioning of a few researchers and teachers in France and Romania:

-What can we include in our research field and/or pedagogical thematic to have a concrete action in sustainable development, while respecting obviously the mains scientific fields of our respective engineering schools and secondary schools ?

Thus, the « small scale house » project was born. The aim was to build a original fully functional modular model of house with genuine construction materials and its “green” energy generation system. The finished model will be used as:

- demonstrator (exhibition in town halls or local sustainable development events)
- educational support for practical lessons and electronic projects, for sensitizing ENSEIRB MATMECA engineering students.

4.2 Scaled house building

The small scale house itself has been finished two years ago. Its building (with true materials) required more than 1500 hours of work including pupils, students and teachers work [1].

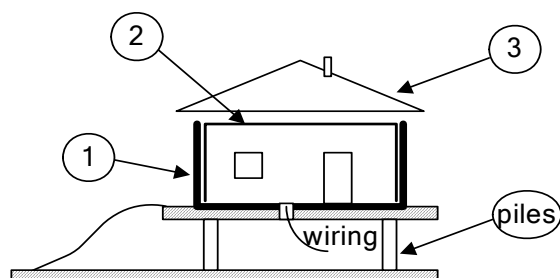

Figure 1: “turned over shoes box” house design

The dimensions of the 1/20 scale house model are 50cm x 50cm. It consists of 3 independent parts (cf. figure 1) according to a concept of “turned over shoes box”: external walls in Autoclaved Aerated Concrete (AAC) 2.5cm thickness (part 1), interchangeable interior insulation double wall and ceiling (part 2), encasable by the top, inside the external walls, single and double glazed windows, removable pitched roof (part 3) with pine tree wood parallel roof truss, (cf. figure 5), attic filled with mineral wool insulation, covered with terra cotta tiles on one slope and with a solar panel on the other side. The “basement” is used for electrical wiring and electronic circuit’s installation.

Figure 2 shows the AAC walls during the building phase.



Figure 2: AAC external walls building

Figure 3 shows the structure of scaled double glazed windows of the house. The space between the two glasses is a simple air gap (of course, no rare gas inside).

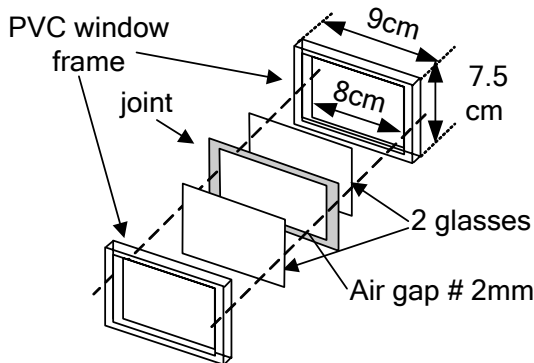

Figure 3: open view of mini double glazed window assembly.

All the windows frames have been cut and machined from the same raw material plate (PVC). Small glasses have been cut from a unique wide glass plate. Machining was programmed on a digital milling

machine. Thus, it guarantees identical geometrical characteristics (thickness and size) and also homogeneous thermal characteristics.

Figure 4 shows the assembled insulation internal walls and ceiling, with window frame and main door. (Example here: PVC frame, cork panel on internal wall and polystyrene on ceiling, among the three possible insulation “boxes”). The box has been turned vertically on one side to take an easy picture.

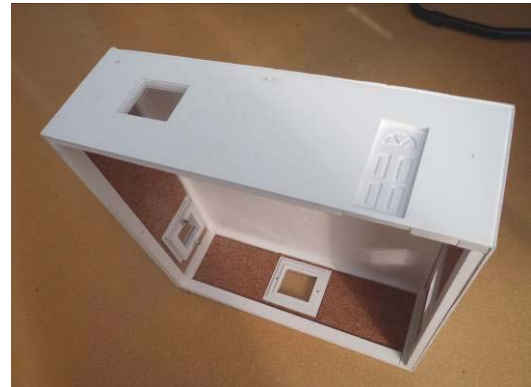

Figure 4: Encasable double wall insulation

Figure 5 shows the roof wood frame, chimney and terracotta tiles.



Figure 5: wood frame and roof

4.3 Power source and electronic equipment

All around the house, some various functional scaled power generators have been installed: mobile solar panel, hydrogen fuel stack, wind generator, solar dish, Stirling engine... The total surface of the whole model represents two wood boards of 80cmx100cm each.

Electronic circuits for powering and managing the house are already designed or going to be designed. A few hundred hours were necessary till now for the design, PCB realisation and house wiring. Of the following equipments:

- Roof solar panel, battery charger and control.
- Low voltage LED lighting for the terrace and house entrance.
- Hydrogen stack management, fan control and house "air conditioned" system (i.e. scaled canadian well under the house).
- Electrical house heater and temperature control.
- Solar water pump for water flow control in an artificial river.
- Simplified solar tracking system for a mobile solar panel.
- Solar tower control.

All these equipments may be disassembled for easy maintenance and transportation.

Figure 6 shows a picture of the finished scale modular and evolvable model.

5. Interest of thermal measurements

5.1 Scientific wide interest

Thermal imaging is a powerful tool to investigate thermal phenomenon in a wide range of civil and/or military applications such as non destructive control, failure analysis, night vision, furnace chimney control, micro electronic, buildings, and so on [8], [9].



Figure 6: View of finished house and surroundings.

Some practical lessons are given since a long time in our IMS laboratory (power electronic department). Main uses are electronic circuit assembly thermal characterisation, failure mechanisms detection for reliability studies.

Researches on evaluation of thermal losses in a house by thermal imaging have been carried out in different countries [10], [11].

Italian researcher's uses infrared analysis for master paintings under layers investigation and detection.

5.2 General public interest

With the technical progress and the growth of the infrared market, the use of thermal camera has been democratized: infrared thermometers or cameras can be found in supermarket.

In particular, "low cost" cameras are now currently used in building trade for energy performance and thermal losses of flats diagnosis [12], [13]. For that matter, diagnosis and display of the performances are mandatory before the sale of a flat in France (official decree in September 2006).

In 2009, Bordeaux was one of the leading cities in France to ask for a full thermal assessment of thermal losses in living building [14], [15]. A thermal cartography of the Bordeaux and suburb [16] has been done flying over and scanning the city with an infrared camera. The collected data's allowed the authorities to suggest improvements of roof insulation efficiency and renovation in faulty houses. All the buildings are now classified as a function of their energy efficiency. And RT 2005 standards have defined high insulation characteristics for the new buildings [17].

5.3 Education interest

With the research background on infrared imaging applied to micro electronic [18] [19], and taking into account the previous paragraphs content, it appears that introducing some practical lessons and theoretical considerations on thermal imaging techniques and tools can be useful in an electronic engineer school.

5.4 Interest of the presented work

The work presented in this paper is one illustration among others, of the general approach explained in §3: Rather than to train our students with the infrared measurement techniques and to apply it to the electronic assembly characterization, the localization of the circuit's hot spots, the components failure mechanisms detection, we chose "to move" the field of application towards sustainable development without modifying or lowering the scientific contents. It can be seen as an opportunity for the teachers to be exemplary in their scientific fields of studies and as well as in their general education role.

It is also a preliminary work to check and to validate the possible uses and performances of the small scale house model. Once validated, experiments should be included in our "measurement techniques" practical lessons in first year of study. Indeed, the small scale house model will offer the possibility to perform "indoor measurements" in the school for a small group of students without the need of heavy infrastructure.

At last, showing thermal losses in a small scale house, discussing and measuring thermal insulation efficiency during practical lessons should act as a sensitizing tool for the future private life, possible positive impact when engineer students will do personal estate transaction, flat or house purchase.

6. Experimental study of the small scale house thermal behaviour

6.1 Infrared camera short description

The infrared camera used for this study is a FLIR B335 with a target preset-able emissivity. Main characteristics are:

- IR analysis range: 7-13 μ m,
- IR sensor matrix: 320 x 240 pixels
- Lens: 25°, manual or autofocus
- IR image superposed or merged with a normal digital image
- Thermal resolution: 0.05°C (at 30°C)



Figure 7: Infrared camera FLIR B335

6.2 Test bench preparation

The small scale house model can be opened from the roof. It is thus possible to install heating power sources sensors... and to remove double internal insulation or to change the insulation materials.

Test bench is prepared as indicated on figure 8. Heating power source, placed into the house, is a 12V DC halogen small spotlight, variable from 0 to 60W.

Indoor and out door temperature small scale house are displayed and checked during all the experiments by temperature sensors.

Working room is closed, shutters are closed and measurements are performed early morning to lower the parasitic effects.

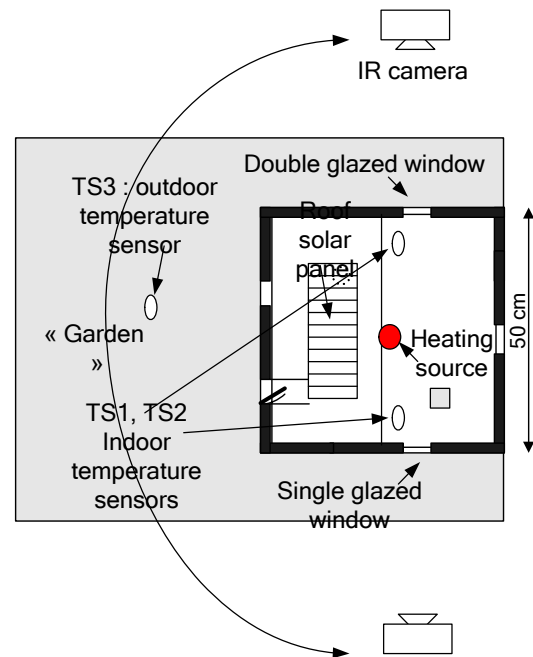

Figure 8: experimental platform

6.3 Emissivity correction or determination

Emissivity correction can be done in two ways:

- Homogenisation of target emissivity by coating it with a high emissivity (close to 1) thin special black painting.
- Automatic « pixel by pixel » correction by digital and software processing on top level camera. In this case target is considered as grey body: emissivity is assumed constant whatever the chosen wavelength for the analysis.

The first method is obviously not applicable for esthetical reasons and the second one's requires a expensive camera with its emissivity correction software.

Emissivity of the different raw materials and house parts has been determined by bibliography or by preliminary test following the method described in references [16], [17].

Fortunately, all raw materials used in house building have a very close emissivity (around 0.95). Thus, a direct reading of surface temperature on infrared image is possible without heavy correction.

7. Experiments

7.1 General operating conditions

Small scale house model is located in a workroom inside the ENSEIRB-MATMECA School. Real conditions (outside measurements) are obviously not

respected. However, small house can be heated more than the room temperature to produce a temperature gradient between inside and outside. For each measurement, the values of the temperature given by the IR camera will be compared to those indicated by the thermocouple K digital thermometer (Keithley 871A).

Only comparative measurements will be performed to obtain credible results. Figure 9 shows a general view of the house model when starting heating source.

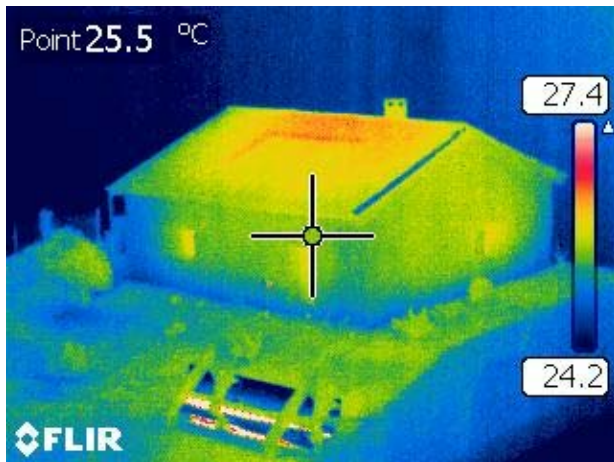

Figure 9: Scaled house infrared general view

7.2 Open/closed door comparison

The heating source is located exactly in the middle of the small scale house and is voluntarily over sized (50W) to increase the temperature difference between indoor and outdoor.

This first test is just to visualize the effect of opening the house door (machined in PVC).

When opening the door, heat obviously goes out mainly in the upper region of the door. Figure 10 and 11 shows comparison door half open door closed.

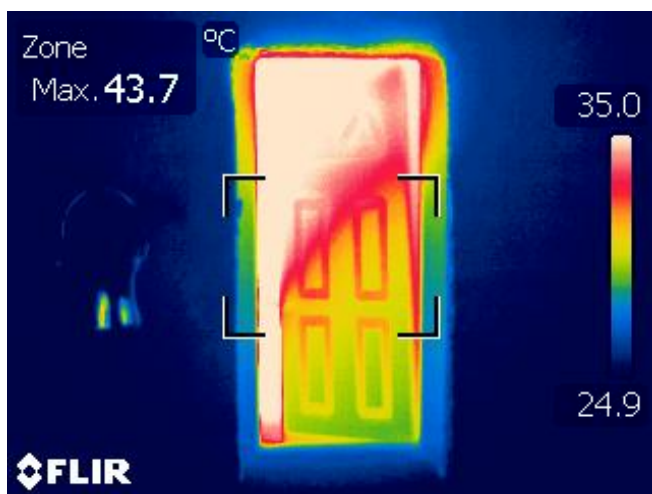

Figure 10: half open main entrance door (heat losses)

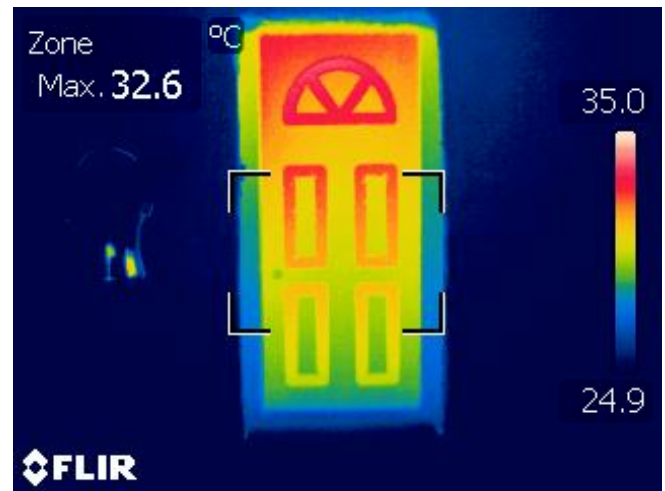

Figure 11: main entrance door closed (surface temperature quite homogeneous)

7.3 Single/ double glazed window comparison

7.3.1 Test operating conditions

Absolute errors on temperature measurement are always possible especially with infrared camera because approximations on emissivity and parasitic IR flux. Thus, to make realistic and reliable analysis, we worked only by a comparative and differential measurement to guarantee representative results. And we set up strong measurement conditions as follows:

- As indicated in paragraph 4.3, windows have exactly the same size and are made with the same material lots to guarantee identical physical properties.
- Heating source is located exactly in the middle of the small scale house equally spaced from the two windows to be tested. The adjustable heating power source (from 0 to 60W) is voluntarily over sized to increase the temperature difference between indoor and outdoor,
- The two matched temperature sensors TS1 and TS2 are two K thermocouples associated to two channels thermometer Keithley 871A. They are located in the house at 5cm from the wall and at 3 cm high to measure the indoor temperature. Matching has been checked over the 0° to 50°C range and is better than 0.1 °C.
- The initial ambient temperature is checked by temperature sensor TS3
- Initial surface external wall temperature identical on the four walls (checked by contactless IR thermometer MO297),

- IR thermal measurements performed after 1/3 hour waiting to insure steady state conditions,
- Camera mode: “merged”, to superpose normal and IR Image for better understanding
- Distance “camera to target”: one meter
- Autofocus on windows with thermal pointer on the middle of the window.

7.3.2 Infrared measurement

Figure 12 and 13 shows example of comparative measurement between single and double glazed windows with an heating power of 60W. House indoor temperature after 1/3 hour reached 41°C (workroom temperature 23.6°C).

On figures 12 and 13, a cross section along the white horizontal line passing through the middle of windows has been extracted (with FLIR reporter 8.5 software). Temperature profile is given in figure 14.

Looking at these three pictures, it is observed that outside surface of double glazed window is colder than the one of the single glazed. The average difference is around 2.8°C. Thus, efficiency and better insulation of double glazed window is shown in the small scale house like in a true house.



Figure 13: Double glazed window

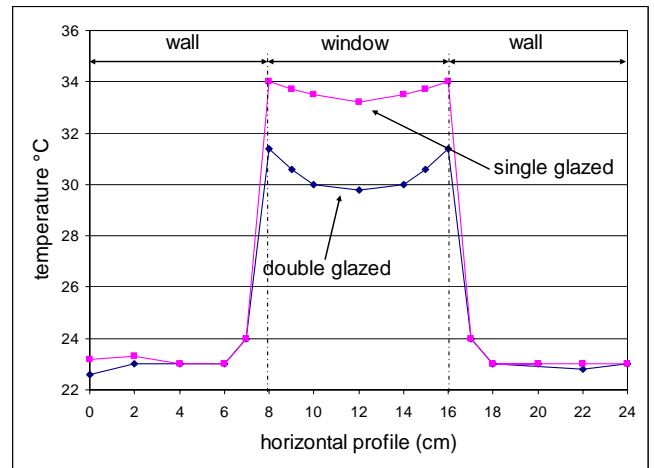

Figure 14: Horizontal temperature profile

Table 1 gives example of measured temperatures for various heating source power values.

Heating power	20W	40W	60W
Outdoor temperature (i.e workroom temp) (in °C)	20.6	20.6	20.6
Indoor scaled house temperature (°C)	26.6	31	39.2
Temp Difference in/out (°C)	6	10.4	18.8
Outside surface temperature single glazed (°C)	24.7	28	35
Outside surface temperature double glazed (°C)	23.6	26	31.7
Delta single/double glazed	1.1	2	3.3

Table 1: Temperature measurements

Figure 12: Single glazed window

Several similar measurements have been performed with different heating power and different work room initial temperature to confirm the previous results.

Figure 15 shows the difference temperature between the outside surface single glazed and double glazed vs. the inside/ outside temperature difference obtained from table 1 and other extended measurements.

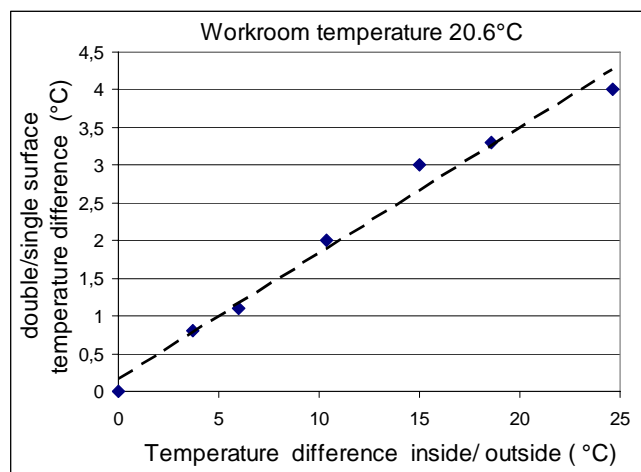

Figure 15: Efficiency of double glazed window

At last, the double glazed window was replaced by a single glazed one's. The same measurements were performed one more time. No significant temperature difference between the two tested windows was detected (less than 0.3°C): improvement in temperature barrier effect comes really from the double glazed window.

7.4 General insulation

Effect of global insulation has been tested by doing the following experiment:

First, the double wall insulation and ceiling insulation was removed. A heating power of 40W was necessary to heat the small scale house at 28.5°C (with a working room temperature of 20.6°C).

Under this condition, figure 16 shows the infrared image of the roof. Rectangular shape on the left slope is the roof solar while the hot point behind the chimney corresponds to a small roof window.



Figure 16: Roof top view without double wall and ceiling insulation

Secondly, we installed the double wall and ceiling insulation. Only a power of 20W was necessary to obtain the same indoor temperature.

Figure 17 shows the infrared image of the roof when insulation is installed. Temperature scale is the same for an easy comparison of the two situations. Heating power was divided by 2 and thermal losses are obviously reduced. The maximum temperature (small roof window) and temperature gradient on the roof are lower.



Figure 17: Roof top view with double wall and ceiling insulation

8. Results discussion and credibility checking

Measurement conditions on the house model are obviously different from the reality. It was important to check tendencies and credibility of the work by making a comparison with a real situation. This was done by performing measurements and data collection over 6 years (before and after renovation), in a renovated apartment in Bordeaux. It was located at the 5th floor, just under the flat roof, on east and north side of a building, built in 1984, with poor/medium initial insulation characteristics, heated by natural gas.

In 2008/2009, this apartment was renovated: global insulation of the flat roof (12 cm of polyurethane foam + bituminous watertightness), north wall insulation (12 cm thickness polystyrene tiles) and replacement of old windows by double glazed windows (4cm/16cm/4cm) has drastically decreased the annual heating power consumption (divided by more than 2) for the same comfort temperature as shown on figure 17.

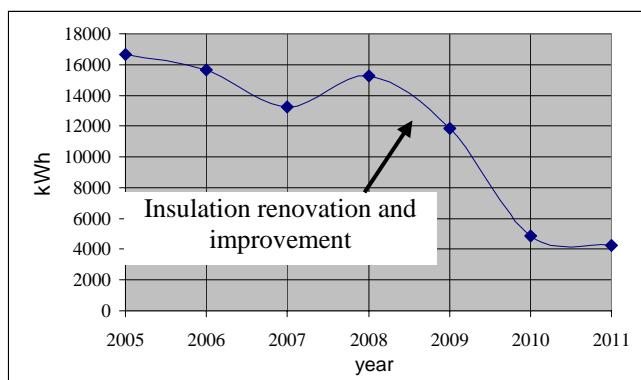

Figure 17: Annual heating energy real consumption (KWh) of the tested apartment

Since only north wall was double insulated, while the east wall was not, it was easy to compare the thermal efficiency of the two. Outside surface temperatures of the two walls were compared using the same infrared camera. Measurements were done late evening in autumn season, when the outside air temperature goes down. Room temperature was 18.5°C. Outside air temperature varies from 6°C to 12°C. Temperature difference between the two wall surface was roughly 0.5°C and 1°C when temperature difference between inside and outside varies from 6°C to 12°C. Same measurements have been done on the same apartment (but without renovated insulation) on the 4th floor, just under. North wall and east wall outside temperatures were identical.

Thus, effects of insulation are similar for the small scale house model and for a true apartment. Compared to a true situation, order of magnitude of the heating power saving given in paragraph 7.4 seems to be realistic. And results given in §7.3.2, are definitively reasonable and validated: In particular, effect of the scaled double glazed windows is demonstrated.

9. General assessment

9.1 Technical benefits

This work was first the opportunity to carry out an infrared camera, in an original application.

As we obtained concrete and positive experimental results, this work will be valorised by transferring and including it first in a measurement techniques practical lesson cycle in first year of study. Later, a more general and transversal “sustainable development” practical lesson should be implemented.

This full practical lesson dedicated to sustainable development will be described in a future publication.

9.2 Pedagogical assessment

Since the beginning of project (house building), 15 students worked on this multi thematic house model thermal equipment:

- 8 pupils from secondary school participated to the house design and some of them attended the first thermal measurements.
- 1 student from Bordeaux IUT GEII (training period 2 months for mechanical integration)
- 2 students from Craiova University (preliminary design)
- 1 training student worked on thermal characterisation.

Moreover, 6 students will work very soon next year on electronic heating system design in second years study.

10. Future work

10.1 Possible theoretical study

We are looking for collaboration with thermal specialists to study a CAD thermal model of the house and to run thermal simulation by finite element with ANSYS or SILVACO software for example.

10.2 Thermal losses measurement and house energy consumption link

In order to make our small scale house as realistic as possible, an electronic circuit to heat the house and regulate the inside temperature is going to be designed. Some ceramic resistors and heating floor will act as electrical heaters driven by an “on/off” PWM signal. By a real time monitoring of the consumption, it will be possible to know the average energy consumption of the house under various conditions; in particular, impact of heater’s position in the house will be investigated. Comparison between heaters fixed below the window like often in true house, or elsewhere), will be easily done and thermal measurement correlated to energy consumption monitoring.

10.3 House model project global continuation

Despite the lack of sponsors, the project will go on: some accessories such as parabolic solar dish and scaled solar tower generator (from Didacsol retailer) [20], [21] are going to be added on the house surrounding. As thermal losses localisation and evaluation is not enough in consumption reduction

process, house energy consumption will be monitored and registered on computer to make the house more "intelligent": A "home automation" mini system will be included very soon.

11. Conclusion

Three years were necessary for ENSEIRB-MATMECA school and its academic partners, to design a functional realistic small scale house, built in genuine materials. It was completed successfully within the framework of an innovative sustainable development project. Thermal behaviour of the house model was investigated by infrared imaging. Thermal losses have been identified like in a true house. Insulation materials efficiency has been checked and demonstrated by a comparative approach.

This work should be now adapted and converted for creating a practical lesson on Infrared measurement techniques. It will be included in the "measurement techniques" module in first year of study at ENSEIRB-MATMECA.

Lastly, we hope that the presented work will help to stir the conscience of students and teachers to the need for sustainable development. We also wish that we will cause some vocations among the students for their future job.

References:

[1] Ph. Dondon- P. Cassagne- M. Feugas- C.A. Bulucea-D. Rosca- V. Dondon- R. Charlet de Sauvage «Concrete experience of collaboration between secondary school and university in a sustainable development project: design and realisation of a realistic small scale house to study electronic and thermal aspect of energy management in an electronic engineering school.» WSEAS TRANSACTIONS on ENVIRONMENT and DEVELOPMENT Volume 7, 2012, ISSN: 1790-5079

[2] Ph. Dondon- C.A. Bulucea - P. Cassagne «Education to Sustainable development in an engineer school: Carbon assessment ® method applied to the design of a realistic small scale house.» WSEAS TRANSACTIONS on ENVIRONMENT and DEVELOPMENT Volume 7, 2013, ISSN: 1790-5079

[3] D. Bourg «25 ans de Développement Durable : Quel bilan?» Conférence Plan Climat Région Aquitaine Jeudi 14 octobre 2010

[4] Atlas du développement durable ed. 2011.

[5] Nicolas Hulot web site: <http://www.fnh.org/>

[6] Ph. Dondon «Introducing sustainable development concept and "human being teaching" in a scientific engineer school: a difficult challenge but a collective

responsibility» plenary lecture, WSEAS EDUCATION and EDUCATIONAL TECHNOLOGY (EDU'09) 17-19 octobre 2009 Genova

[7] N. Taoussandis, M. Antoniadou «Sustainable engineering education : justified and justifiable» WSEAS EDUCATION and EDUCATIONAL TECHNOLOGY (EDUCATION '10) 22-24 July 2010 Corfou Greece

[8] G. Gaussorgues «La thermographie infrarouge Principes - Technologies – Applications» ed. Tec et Doc 1999 ISBN : 2-7430-0290-5

[9] D. Pajani « Mesure par thermographie infrarouge » ADD editeur ISBN 2-9504171-0-8. 1989

[10] I. Benkö «Thermal detection of buildings and environment by INFRAMETRICS devices» Proceedings of the Second Trabzon International Energy and Environment Symposium. Ed. I. Dincer and T. Ayhan, pp. 205-208 Begell House, Inc. New York, 1999.

[11] I. Benko «Quantitative analysis of thermal bridges of structures through infrared thermograms» QIRT 2002 - Quantitative InfraRed Thermography 6 , Book of Abstracts, pp.160-161, Dubrovnik, Croatia, 2002.

[12] J.R. Martinez-De Dios, A. Ollero «Automatic Detection of Windows Thermal Heat Losses in Buildings Using UAVs» Proceedings of Automation Congress WAC '06 24-26 July 2006

[13] F. Mokhtari 1, N. Ait Messaoudène 2, A. Hamid 2 et M. Belhamel « Etude du comportement thermique d'une maison munie d'un système de chauffage solaire » Revue des Energies Renouvelables Vol. 9 n°4 2006

[14] J-B. Henry, S. Pierrard, P. Ridoux « Thermographie aérienne des villes, Mythes et réalités » Revue XYZ N° 118 – 1er trimestre 2009

[15] http://www.universityscanir.com/papers/The_Benefits_of_Aerial_Infrared_Thermal_Mapping.htm

[16] http://cartethermolacub.fr/cub_thermo/flash/#

[17] [http://fr.wikipedia.org/wiki/Réglementation_thermique_\(France\)](http://fr.wikipedia.org/wiki/Réglementation_thermique_(France))

[18] D. Darrouzes, Ph. Dondon, Ch. Zardini «Caractérisation en puissance des condensateurs céramiques multicouches par thermographie infrarouge» EPF' 94 28-30 septembre 1994 ENS Cachan (France)

[19] Ph. Dondon - E. Woïrgard - Ch. Zardini «Thermal Transient Characterization of Electronic Assemblies by Infrared Thermography and DeltaVbometer Methods» SEMI TERM IEEE conference 1-3 février 1995 San José CA USA

[20] <http://didacsol.com/>

[21] http://fr.wikipedia.org/wiki/Tour_solaire