

Dynamic Energy Efficient Topology for Wireless Ad hoc Sensor Networks

N. Thangadurai¹, Dr. R. Dhanasekaran², R.D.Karthika³

¹Research Scholar, Research & Development Centre, Bharathiar University, Coimbatore, India.

²Director-Research, Syed Ammal Engineering College, Ramanathapuram, India.

³PG Scholar, Telecommunication Networks, SRM University, Chennai, India.

Abstract - Wireless Sensor Ad hoc Networks (WASNs) are self organizing, self-configuring and multi-hop wireless networks, in which each node communicates with other nodes directly or indirectly through intermediate nodes without any infrastructure. Besides these characteristics challenges like limited energy, dynamic topology, low bandwidth and security exists. The arrangement of nodes in WASN is called topology which changes dynamically with respect to time and mobility of nodes. Energy conservation is a major challenge because of the limited battery resource. In order to conserve energy in the network layer many techniques were used. These techniques can be classified mainly into two categories. The first technique is making small number of nodes awake to transfer bulk amount of data and to maintain the network connectivity and making the remaining nodes to be in sleep mode to conserve energy. This technique is effective for low traffic conditions. In the second technique, topology in the network is controlled by power control technique. This technique is effective for high data traffic. To conserve energy in an efficient manner, an Energy Efficient Traffic Topology dynamically adjusts network topology for various network traffic conditions in WASN either in low traffic or high traffic is proposed here. And the proposed protocol is stimulated by using AODV as routing protocol using network simulator ns2.34 and compared with AODV and DSR [1,2]. The simulation results revealed that the proposed scheme performs well in terms of energy, delay, delivery ratio and mobility and number of nodes alive.

Key-Words: - AODV, DSR, Energy Efficient Topology, Routing Algorithm, WASN

1 Introduction

A WASN is a system of autonomous sensor nodes that communicate over wireless link without any preinstalled infrastructure [3]. It is rapidly deployed and self configuring network. It does not need any existing infrastructure. Nodes are mobile and topology can change dynamically. Fig.1 shows that WASN can be a standalone network or it can be connected to external networks like Internet. Which are useful in places that have no communication infrastructure or when the infrastructure is severely damaged. Its application includes tactical networks, disaster recovery services, metropolitan area, communication networks and enhanced cellular networks. In WASN the dynamic topology is a major challenge. It is the description of the arrangement of WASNs and it usually changes temporarily or dynamically with time. To overcome this, several topology control algorithms and protocols are developed which enables minimum energy consumption, reliability low cost link, and efficiency. Several methods have been proposed to reduce energy consumption and traffic in dynamic network topology [4, 5]. This method gives us various techniques to conserve energy.

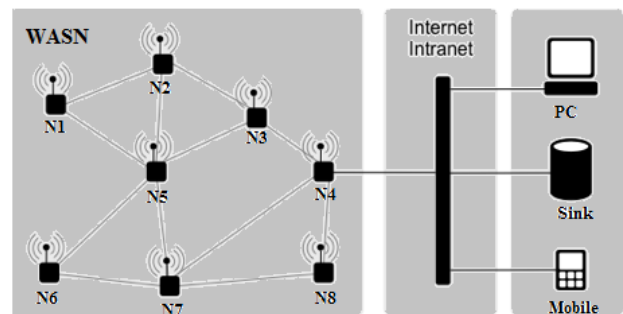

Fig.1 Wireless Ad hoc Sensor Network

The first technique is making small number of nodes awake to transfer bulk amount of data and to maintain the network connectivity and making the remaining nodes to be in sleep mode to conserve energy. This technique is effective for low traffic conditions. In the second technique, topology in the network is controlled by power control methods. This technique is effective for high data traffic conditions. Power consumption in data transfer dominates the power required to keep nodes awake. A proposed Energy Efficient Traffic Topology is dynamically adjusting network topology for various network traffic conditions in WASN. It dynamically selects

the routing strategy on the basis of the energy of the node. It enhances the scalability of WASN and prolongs the network lifetime as well.

2 Related Works

Different types of topologies are proposed in the literature to minimize the energy consumption. These Methods can be classified in to centralized and distributed topology for controlling topologies. For WASN, topology should be maintained in distributive and localized manner.

2.1. Minimum Power Topology

In WASN, the mobile nodes communicate with each other either through a single-hop or multi-hop to relay the message [6,7,8]. The mobile node can adjust the transmission power according to its neighbour nodes. It is one of the ways to reduce energy consumption. Power efficiency is very important in WASN because the network nodes and its life are depending on the battery power. If a path consumes least power among all other paths, then it is a valid minimum power path. Transmission graph is used to find the transmission range of nodes. Distributed algorithm is used to find the minimum energy topology for a set of nodes. Through this the receiver's cost can be neglected. Basically, in mobile network each node often moves over the time. So the networking protocol must be dynamically updating its links by using the minimum power topology. Length of the path is measured in terms of energy consumption. This algorithm is used only for local information.

2.2. Local Minimum Spanning Tree (LMST)

LMST is based on the minimum spanning tree topology control algorithm [9,10,11,12]. Their important properties are: (i) The topology derived under LMST preserve the network connectivity (ii) The node degree of any node in the resulting topology is bounded by six. (iii) The topology can be transformed in to one with bi- directional links without impairing the network connectivity after removal of all unidirectional links. Due to a small node degree the MAC-level connection and interference can be reduced. Topology formation capacity consists of only bidirectional link is important for link level acknowledgment. But it is critical for packet transmission and retransmission over the unreliable wireless medium. Bidirectional

link is useful for the medium access control mechanism such as RTS/CTS in IEEE802.11. The design guidelines of the LMST are the network, that must use only minimum possible power and the algorithm should be distributed. Algorithm should depend only on the information collected locally. And also it should have less overhead and delay during the collection of information. And it must ensure the existence of reverse path. A small node degree in the network should be kept to mitigate the well known hidden and exposed terminal problem. And remaining nodes must be in silence during a communication activity. This algorithm is composed of three phases: information collection, topology construction and determination of transmission power. It has a maximum degree of 3 and minimum degree of 1 and average degree of 2.06. It reduces the MAC level connection which implies only small transmission power is needed to maintain connectivity.

2.3. Localized Distributed Topology Control Algorithm (XTC)

Topology control in the WASN tries to minimize the energy consumption by reducing transmission power and interference collision and consequent retransmission. Topology control is like coordinating the nodes regarding to their transmitting range to generate the network with desire features. Changing of neighbour based topology control XTC for Wireless Ad hoc sensor Network and evaluates AODV with XTC algorithm under nodes mobility [13,14,15]. It consumes less power and gives better life time to the network. XTC is the most realistic neighbour-based topology control algorithm. XTC algorithm consists of three steps: neighbour order, neighbour order exchange and link selection. In neighbour order, each network node computes the total order of all its neighbours in the network graph, G. This type of order is intended to enhance the quality of the links to the neighbour. In neighbour order exchange, it exchanges the order among all the neighbours. In link selection, each node selects the neighbouring node to form its neighborhood in the topology control graph based on the previously exchanged neighbour order information. It does not assume the network graph to be a unit disk graph. It works on weighted node graphs and it does not require any availability of node position.

2.4. Local Information No Topology (LINT)

In the Wireless sensor Network the topology is changing constantly. There is a continuous adjustment of the transmitted power of the nodes to maintain the desired topology [16,17]. LINT is one of the distributed control topology. It is a zero-overhead protocol. It means it does not use any special control messages for their operation. LINT uses locally available neighbour information which was collected by the routing protocol. It attempts to keep the number of neighbours of each node bounded the LINT. It does not clearly introduce control overhead and the adjustment of transmit power may cause link up/down. Three parameters were used to configure a node degree. (i) The desired node degree dd (ii) a high threshold on the node degree dh (iii) low threshold dl . The node continuously checks the number of active neighbours in their neighbour table which is built by routing mechanism. Suppose the degree is greater than dh , then the node increases its operational power. If it is true then no action or decrease in power is taken bounded by the maximum and minimum possible power settings of the respective radio. The magnitude of the power changes due to a function of desired degree dd and current degree, d . The power changes are done in a shuffle periodic mode.

2.5 Local Information Link- state Topology (LILT)

LILT is the distributed topology control. It is a zero overhead protocols i.e. it do not use any special control message for its operation [17,18]. It uses the freely available neighbour information and it exploits the global topology information which is available with routing protocols like link-state protocols. LILT do not explicitly introduces control overhead and adjustment of transmitted power which causes link up or down. Many topologies include updates which will require more network bandwidth and it decreases the throughput efficiency. To overcome this problem LILT increments to calculate the new transmit power not from scratch but from the currently used values. It is global topology information used for recognizing and repairing the network partitions. It can be divided in to two parts: Neighbour Addition Protocol (NAP), Neighbour Reduction Protocol (NRP). LINT presents the connection between the squads. The NRP uses LINT mechanism and tries to maintain the node degree around a certain configured values. NAP is triggered whenever an event driven or periodic link

state update arrives. The main challenge is to coordinate power changes with other nodes because all nodes are not necessary to react at the time of topology change. Once a node receives a routing update it first determines in which of the three states it belongs to: (i) disconnected (ii) connected (iii) but not connected or biconnected. It is biconnection no action can be taken. It disconnects the node which increases its transmitting power to the maximum possible value. It is connected, but not biconnect the node attempts to do biconnectivity augmentation. The nodes first find the distance from the closest articulation point. The network is connecting and not biconnect then it have at least one articulation point. That point will be automatically found by the biconnectivity checking procedure. The node set the time t , which must be a randomized around an exponential function of the distance from the articulation point. After the time t , if the network is still not connected then the node increases the maximum possible power. Global coordination having limited form is achieved with zero overhead. The nodes which always remove the articulation and it prefer to using timers. The overhead evaluating AP using DFS in the form of $O(N+E)$. And the overall overhead evaluation in the form of $O(2N+E)$. This can be a summary of neighbour adaption and AP evaluation overhead.

2.6 Distributed Novel Topology Control Algorithm (Dist-NTC)

In Dist-NTC all nodes are broadcasted to their own existence and it collects neighbour information within their maximum transmission Range, R [19,20,21]. Each node finds their adjacent DT neighbours within the range. And each node keeps only a fixed number of shortest edge and it inform other edges about their specified edges and it rejects other edges expect the specified edges. In the network node which is less than the specified edge are classified as "active". Every active node works under distributed mechanism procedure and it finds the nearest active node and sent packet request and waits for its reply. The network link which arises due to the matching link procedure is called non-basic link. If the neighbour node sends any acknowledgment to the active neighbour then the edge is added. But the active node accepts only the nearest node. This process can be repeated until the numbers of adjacent edges are equal to the fixed value or no other nodes in the range are available for matching. This distributed

matching procedure was used by the active node. It is not suitable for non active node. Suppose if it does not find any active node or enough link then the active node become non active node. The computation overhead of this network N is $O(NL)$.

2.7 Distributed Relative Neighbourhood Graph (Dist-RNG)

This is a distributed topology control algorithm which has distributed intelligence to construct a topology with some optimization objectives like minimizing the node degree, the hop diameters of the network and the maximum transmission radius [22,23]. It performs well in terms of power usage, low interference and reliability. This topology is used for different transmit powers and nodes to meet a global topological property like connectivity and biconnectivity. The main aim of this topology is to minimize the transmit power. This distributed algorithm is used for computing RNG based topology. During execution in Dist-RNG consider a node f_i that grows its transmission power to the nearest neighbour f_j which can be found in the uncovered region. If the node is found an edge (f_i, f_j) is added to RNG. From the newly found f_j an angle θ_j is calculated. θ_j defines a cone that jointly covers the span area by f_j . Initially θ is set to zero. The whole process will be repeated until it reaches the maximum power. The computational overhead for this algorithm is $O(N \log N)$.

3 Integrated Routing Protocol With Energy Efficient Traffic Topology

The energy consumption in Wireless Ad hoc Sensor Network (WASN) can be minimized, by dynamically adjusting the topology for various network traffic conditions. The proposed Energy Efficient Traffic Topology by incorporating AODV [24] routing protocol contains three phases.

3.1 Selection of nodes for transmitting data.

Selection of nodes is used to transfer a data from source node S , to destination node, D . Fig.2 shows the source node checks its path cache whether it already contains a path to the destination node. If a valid path exists to the destination then it starts sending its data. If the source node does not have a valid path to the destination node, it undergoes the selection of nodes for transmitting data process by broadcasting a path request (PREQ) packet. The path

request packet contains the data like address of the source node and the destination node, and a unique identification number for transmission. An intermediate node, I which lies between source node and destination node receives a path request packet. It checks its path cache for a transmit data to destination node. If the path exists then it transmits the data packet to the next intermediate node. The message propagates through the network until it reaches either the destination node or an intermediate node with a path selection process to the destination. Once a packet reaches a destination it sends path Reply (PREP) packet to the source node. The PREP containing the proper hop sequence for reaching the destination is generated and unicast back to the source node.

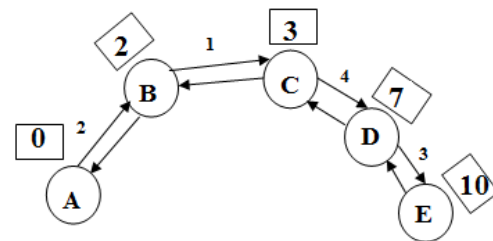

Fig.2 Selection of nodes for transmitting data

Destination node D first receives path request packet (PREQ) then it calculates the path cost and update its path table. It have fixed time interval to receive more path request packet to find the least cost of path among them. After receiving the packet, Destination node D unicast a path Reply (PREP) back to its neighbour from which it receive the least cost route. Suppose node D does not receive any packet from the node S then node D unicasts route error RERR towards the source node.

3.2 Mobility of nodes

Mobility of nodes causes link failure there are three types of link failure: Self failure, Path failure, Sink failure are the three types of link failure. Fig.3 when the node fails itself because of crash, re-boot, bug in software code, or connectivity issue it is called self failure. The path failure makes other nodes to fail at the time of transmission or it cause collision along the paths. Sink failure makes the whole network to fail and it cause in the base station. Bad sink placement, changes in the environment after deployment, and connectivity issues are the main reason for sink failure. Automated link failure and

Interference Detection Avoidance (AIDA) module determines it and changes the channels for any AP that experiences high levels of RF interference. The AIDA module monitors all channels, including unused channels in order to perform this service.

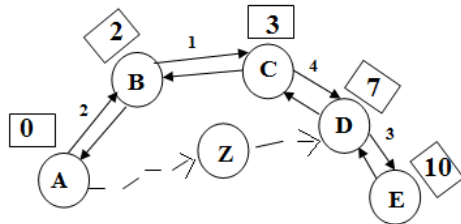

Fig.3 Mobility of nodes

3.3 Alternate path selection with minimum link cost.

Alternate path selection with minimum link cost scheme in WASN is to reduce the time delay and control overhead in the network. During data transfer from source node to destination node maintaining connectivity with the sink node in the base station without any interruption becomes a major issue. More nodes are typically deployed to reduce possible node failures. When large number of nodes fails in the same region it may cause loss of connectivity with the sink node and it reduces the efficiency of the network transmission.

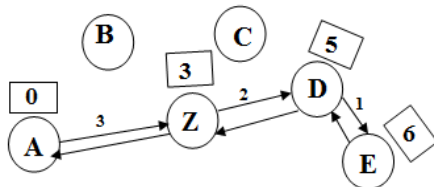

Fig.4 Alternate path selections with minimum link cost

Fig.4 shows due to node mobility link failure occurs for recovery, source node finds alternative path to transmit the packet to destination. Route recovery is based on maintaining the route information at each node to the sink and then utilizing such information for the relocation of the nodes. Route recovery scheme is to solve the link failure problem caused by node movement, packet collision or bad channel condition. Route recovery considers backup nodes mobility and conducts route recovery implicitly and provide reliable and stable route for routing protocol. Energy Efficient Traffic Topology for WASN, which

dynamically changes the topology according to the network traffic requirements.

Fig.5 shows the proposed routing algorithm is used for transmitting data in the network as follows:

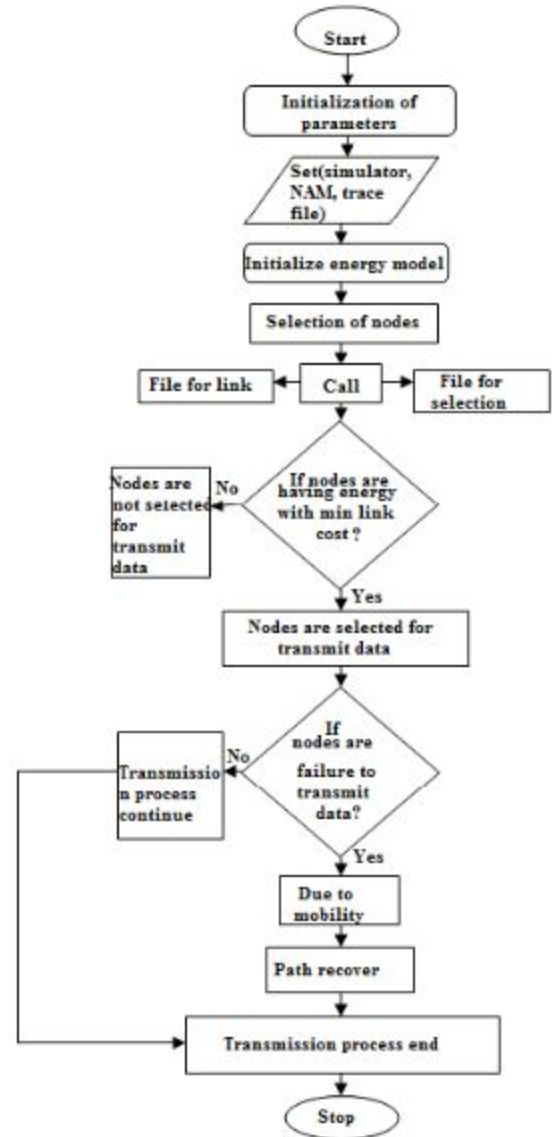

Fig.5 Algorithm for proposed protocol

4 Simulation Results

Table.1 shows the parameters assigned to simulate the WASN Environment.

S.NO	PARAMETERS	VALUES
1	Simulation time	100 s
2	Number of nodes	38
3	Max node energy	1000J
4	Energy distribution	Normal distribution(0-1000J)

5	MAC	IEEE 802.11
6	Max TX power	0.2W
7	Max RX power	0.09 W
8	Routing protocol	AODV
9	Propagation model	Two ray ground
10	Node motion	Random motion
11	Area	500x500m ²

Table.1 Simulation Parameters

4.1 NAM Results

Fig.6 shows at the time of simulation, node needs to send a packet from source to destination. For that it finds the nodes based upon demand, maximum energy and minimum link cost. It sends a path request (PREQ) to the nodes which are selected with minimum link cost and waiting for the path reply (PREP) from the intermediate nodes which are selected for transmitting data.

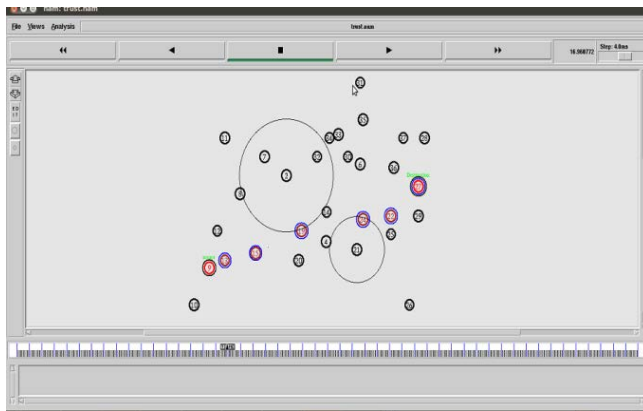

Fig.6 Selection of nodes for transmitting data

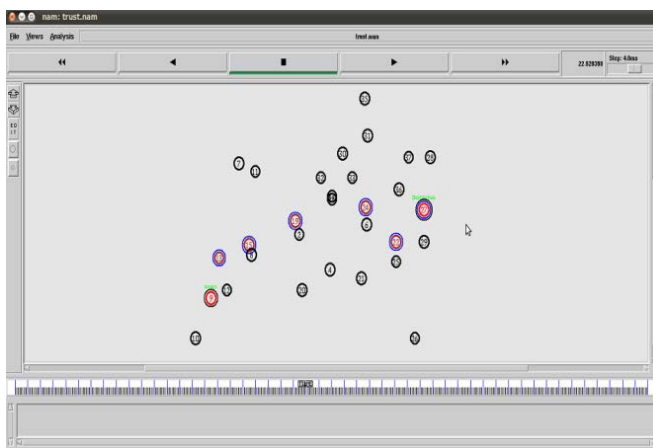

Fig.7 Mobility of nodes

After getting reply from all the intermediate nodes, the source node starts transmitting packet to the destination. Fig.7 & 8 shows during transmission, if nodes fail to transmit packets to the destination due to mobility it is called link failure.

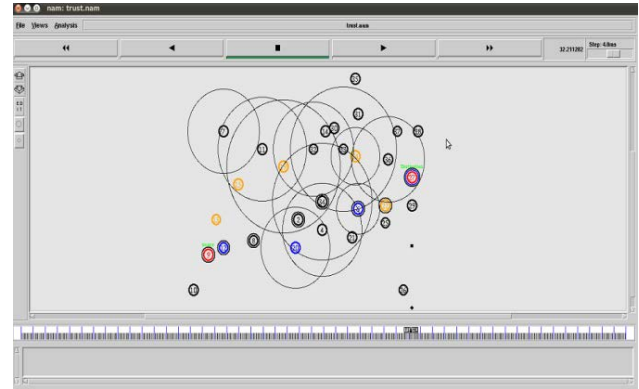

Fig.8 Link failure

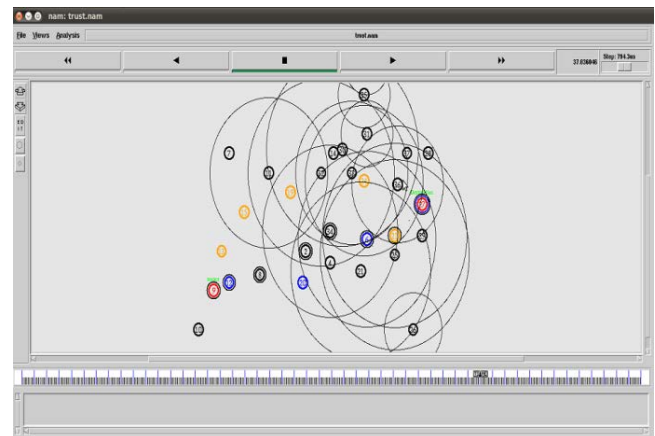

Fig.9 detecting alternate path for transmission

Fig.9 shows to overcome the link failure, the source node finds alternate path with minimum link cost depending upon energy and demand of the nodes to transmit the packets to the destination. This type of routing needs only few nodes to transfer packets and make other nodes to be in sleep mode to minimize energy consumption keeping lesser link cost. The proposed Energy Efficient Traffic Topology is suitable for various conditions like low traffic and high traffic. It increases the life time of the network and on other side it keeps less number of nodes to transfer bulk amount of data by providing minimum link cost with minimum energy consumption.

4.2 Performance Evaluation.

The performance of Energy Efficient Traffic Topology with AODV as a routing protocol is evaluated and it is compared with DSR using the network simulator ns2.34.

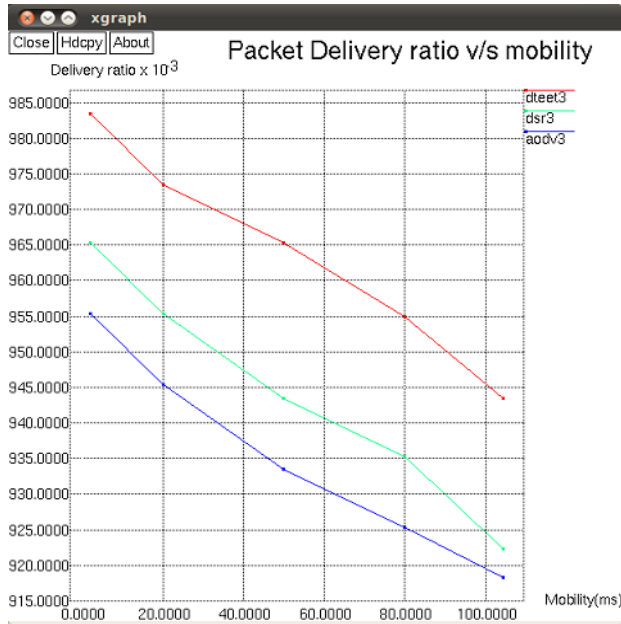

Fig.10 Packet Delivery Vs Mobility

Fig10 shows proposed protocol Energy Efficient Traffic Topology having high packet delivery ratio compared to the other protocols like AODV and DSR during mobility of nodes.

Packet delivery ratio: Packet delivery ratio is the ratio of the data packets received at the destination to the data packets sent out from the source. As the time rate increase, the delivery ratio always decreases and also when mobility increase, the delivery ratio always decreases. Energy Efficient Traffic Topology performs better compare to AODV and DSR.

Fig.11 Shows during transmission of data from one node to another node the proposed Energy Efficient Traffic Topology provide better delivery ratio during high network load traffic due to mobility compare to other routing protocols like DSR and AODV.

Fig.12 Shows during transmission of data from one node to another node the proposed Energy Efficient Traffic Topology provide better delivery ratio during low network load traffic due to mobility compare to other routing protocols like DSR and AODV.

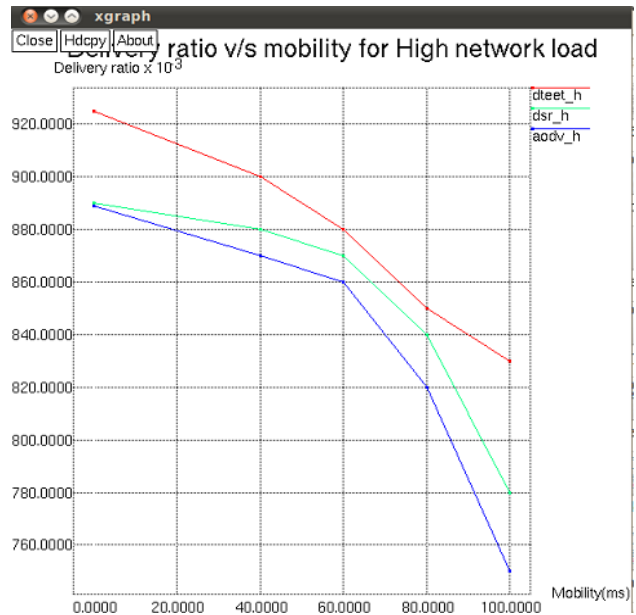

Fig.11 Delivery ratio Vs mobility for High network load

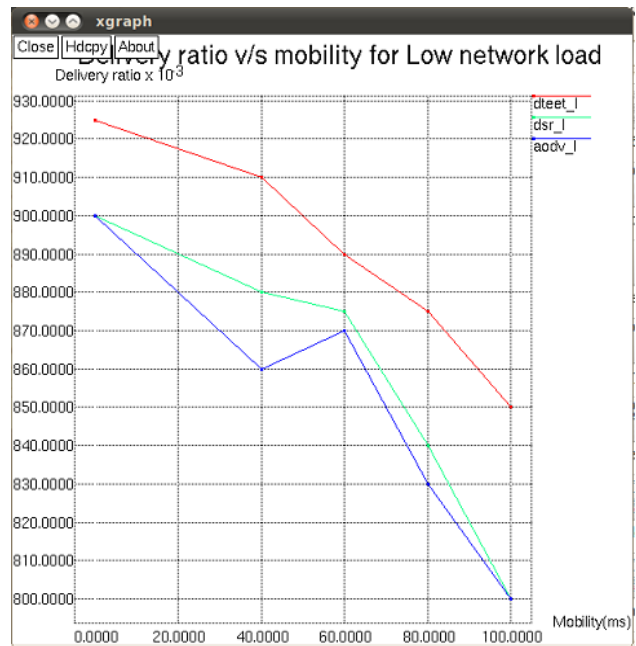

Fig.12 Delivery ratio Vs Mobility for low network load

Energy consumption: The energy consumed by Energy Efficient Traffic Topology by using AODV is less when compare with DSR and AODV routing protocol because of the power controlled transmission.

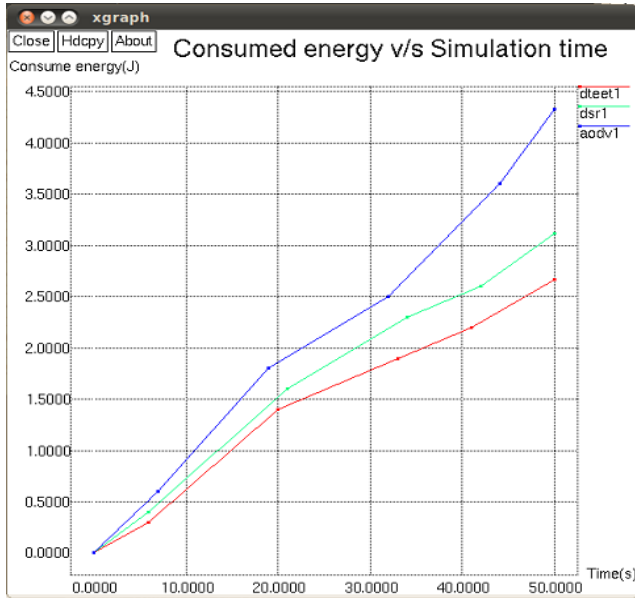

Fig.13 Consumed Energy Vs Time

Fig.13 Shows energy consumed by Energy Efficient Traffic Topology is very less compared to the other protocols like AODV and DSR for 50 sec.

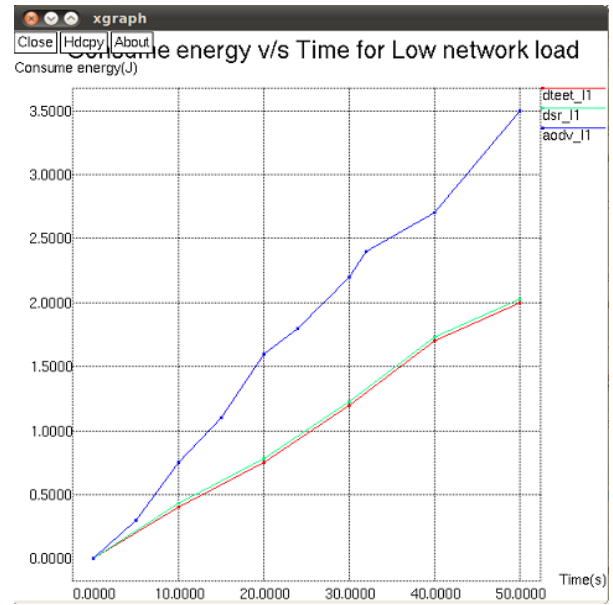

Fig.15 Consume energy Vs Time for low network load

Fig.15 Shows energy consumed by Energy Efficient Traffic Topology is very less compared to the other protocols like AODV and DSR for 50 sec during low network load traffic.

End-to-end delay: The delay is the average time between data sent out from the sources and received at the destinations. Energy Efficient Traffic Topology performs better compared to other AODV and DSR. This is because of low transmission power and low queuing delay reducing interference.

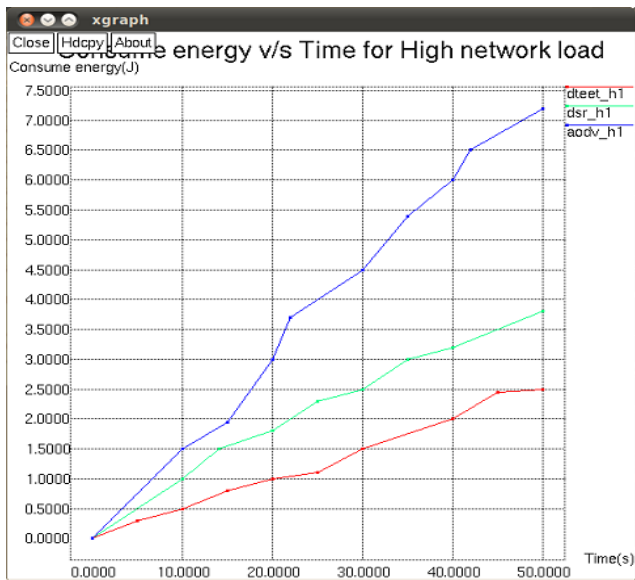

Fig.14 Consume energy Vs Time for high network load

Fig.14 Shows energy consumed by Energy Efficient Traffic Topology is very less compared to the other protocols like AODV and DSR for 50 sec during high network load traffic.

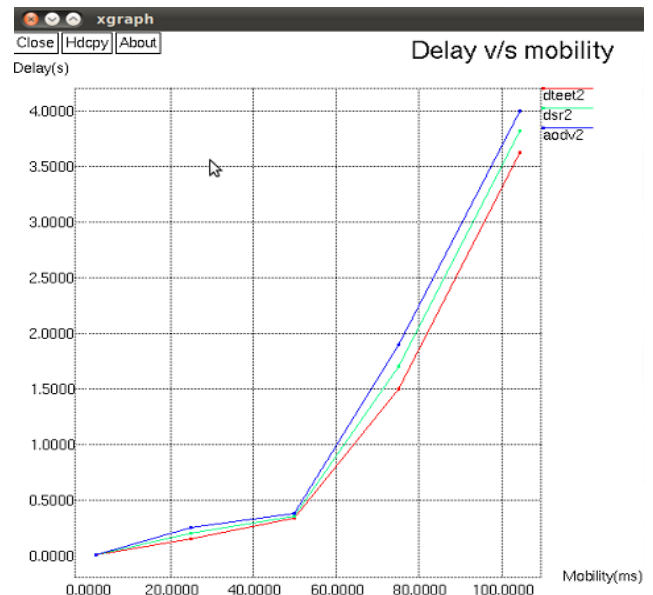

Fig.16 Delay Vs Mobility

Fig.16 shows during transmission of nodes, end to end delay is less in Energy Efficient Traffic Topology compared to the other protocols like AODV and DSR.

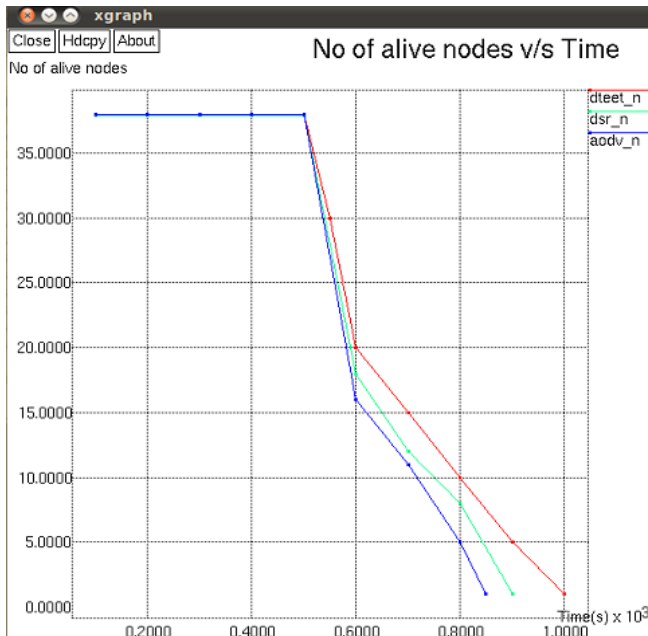

Fig.17 No of alive nodes Vs Time

Fig.17 Shows number of nodes alive at the time of transmission is more in proposed Energy Efficient Traffic Topology compare to other protocols like AODV and DSR.

5 Conclusion

We proposed an Energy Efficient Traffic Topology protocol that dynamically adjusts its topology for both low and high network traffic conditions. We have simulated our proposed Energy Efficient Traffic Topology by using AODV as routing protocol. The simulation studies reveals that the proposed Energy Efficient Traffic Topology gives us best performance in terms of energy, delay, mobility and delivery ratio. And also our proposed algorithm compared with the existing routing protocols to show the difference in performance.

REFERENCES

- [1] Taksande v.k, kulatt K.D, “ A Simulation Comparision among AODV, DSDV, DSR protocol with IEEE 802.11 MAC for Gird Topology in MANET”,IEEE/ International conference on Computational Intelligent and Communication Networks (CICN), 2011,pp:63-67
- [2] Tamilarasi.M, Shyam Sundar V.R, Haputhanthri V.M, sumathilaka.c, babu N.R, chandramathi.s,

palani velu T.G, “ Scalability improved DSR protocol for MANETs”, IEEE/ International conference on Intelligence and multimedia Application,2007. Vol.4,pp:283-287.

[3] Pravin ghosekar, Girish Katkar, Dr.pradip Ghorpade, “Mobile AdHoc Networking: Imperatives and Challenges”, IJCA special Issue on Mobile AdHoc Networks(MANETs) 2010.

[4] Sabina Barakovic, Suad kasapovic, jasmine barakovic, “Comparison of MANET Routing protocols in Different Traffic and Mobility models”, Telfor Journal, Vol.2,No.1, 2010.

[5] Shivendu Dubey, Rajesh shrivastava, “Energy using Traffic models for MANET Routing protocols”, International Journal of smart sensor and AdHoc networks(IJSSAN), Vol.1.1,Iss:1,2011.

[6] Xiang-Yang Li and Peng-Jun Wan , “ Constructing minimum energy mobile wireless network,” SIGMOBILE Mob. Comput. Commun. Rev., 5(4):55–67, 2001.

[7] X.Y.Li,P.J. Wan,Y. Wang, “ Power Efficient and Sparse spanner for wireless adhoc networks,” ICCCN, 2001.

[8] V. Rodoplu and T.H. Meng , “Minimum energy mobile wireless networks,” In proceedings of the 1998 IEEE international Conference on Communications, ICC’98, volume 3, 1998.

[9] N. Li, J.C. Hou, and L. Sha , “ Design and analysis of an mst-based topology control algorithm”. In INFOCOM 2003, Twenty-Second AnnualJoint Conference of the IEEE Computer and Communication., IEEESocieties, pages 1702 – 1712, mar. 2003.

[10] C. Kee, H. Jun, D. Yun, B. Kim, Y. Kim, B. W. Parkinson, T. Langenstein, S. Pullen, and J. Lee, “Development of indoor navigation system using asynchronous pseudolites,” in Proc. 13th International TechnicalMeeting of the Satellite Division of the Institute of Navigation (ION GPS2000), Salt Lake City, Utah, United States, Sept. 2000, pp. 1038–1045.

[11] C. Monma and S. Suri, “Transitions in geometric minimum spanning trees,” in Proc. ACM Symposium on Computational Geometry, North Conway, New Hampshire, United States, 1991, pp. 239–249.

[12] I. Chlamtac and A. Farago, “Making transmission schedules immune to topology changes in multi-hop packet radio networks,” IEEE/ACM Trans. Networking, vol. 2, no. 1, pp. 23–29, Feb. 1994.

- [13] Naghshegar, A. Dana, A. Darehshoorzadeh, and K. Karimpoor, “*Topology control scheme in WASNs for aodv routing,*” In Information and Communication Technologies: From Theory to Applications, 2008. ICTTA 2008, 3rd International Conference on, pages 1–6, 7-11 2008.
- [14] P. Santi, “*Topology control in wireless ad hoc and sensor networks*”, ACM Computing Surveys, Vol. 37, No. 2, pp. 164–194, June 2005.
- [15] R. Wattenhofer and A. Zollinger, “*Xtc: A practical topology control algorithm for ad hoc networks,*” The 4th international workshop on algorithms for wireless, mobile, ad hoc and sensor networks (WMAN), 2004.
- [16] Ramanathan R. and Rosales-Hain R, “*Topology control of multihop wireless networks using transmit power adjustment,*” in Proc. IEEE INFOCOM, 2000.
- [17] T.S. Rappaport., “*wireless communication,*” principles and practice, prentice-hall, 1996.
- [18] S. Ramanathan, M. Steenstrup, “*Hierarchically-organized, Multihop Mobile Networks for Multimedia Support*”, A CM/Baltzer Mobile Networks and Applications, Vol. 3, No. 1, pp 101-119.
- [19] Hu L, “*Topology control for multihop packet radio networks,*” in Communications, IEEE Transactions on, Vol.41, Iss.10, Pages: 1474- 1481, 1993.
- [20] L. Kleinrock and J. Silvester, “*Optimum transmission radii for packet radio networks or why six is a magic number,*” Nat. Telecom, Conj, Dec 1978.
- [21] L. Roston and P. Sen, “*A rule-based system for packet radio network design,*” in Proc. IEEE INFOCOM, 1989, pp. 512-519.
- [22] Chi-Fu Huang, Yu-Chee Tseng, Shih-Lin Wu, and Jang-Ping Sheu, “*Distributed topology control algorithm for multihop wireless network,*” in Neural Networks, 2002. IJCNN '02, Proceedings of the 2002 International Joint Conference on, Vol.1, Pages: 355-360, 2002.
- [23] Roger Wattenhofer, Li Li, Paramvir Bahl, and Yi-Mi Wang, “*Distributed topology control for power efficient operation in multihop wireless ad hoc networks,*” in Proc. IEEE INFOCOM 2001 Conference, April 22-26 2001, Anchorage, Alaska.
- [24] Pirzada A.A, McDonald.C, “*Secure Routing with the AODV protocol*”, Asia-Pacific Conference on Communications, 2005, pp:57-61.