

CMOS Realization of Fully Electronically Tunable Single Resistance Control Mixed Mode Biquad Filter Employing Single VDTA at $\pm 0.6V$

¹GHANSHYAM SINGH, ²HAMEED PASHA, ³H.C.HADIMANI, ⁴SHAFIQU L ABIDIN, ⁵ZULEKA TABBUSM

¹Dept. of Electronics & Communication Engineering,
Jayamukhi Institute of Technological Sciences, Narsampet Warangal (JNTUH) ,Hyderabad, INDIA

²Dept. of Electronics & Communication Engineering
Jayamukhi Institute of Technological Sciences, Narsampet Warangal (JNTUH) Hyderabad, INDIA

³Dept. of Electronics & Communication Engineering
GM Institute of of Technology (Affiliated with VTU), Davangere, Karnataka -233377, INDIA

⁴Dept. of Computer Science, Aligargh Muslim University, Aligargh, INDIA

⁵Dept. of Electronics & Communication Engineering, Jayamukhi Institute of Technological Science,
Narsampet, Warrangal (JNTUH), Hyderabad, INDIA

Abstract— This paper presents a single VDTA based Mixed Mode type Biquad filter. The proposed Transadmittance Mode (TAM) type Biquad filter configuration employed single voltage differencing transconductance amplifier (VDTA) as an active building block, three passive element namely one grounded resistor, one grounded capacitor and one floating capacitor. The proposed transadmittance Mode multifunction Biquad filter configuration is presenting transadmittance mode type four basic standard filter functions low pass, high pass, band pass, band reject or band stop or band eliminate filter responses. These four type filter responses are realizing simultaneously with the selection of single input voltage signal. The proposed Transadmittance Mode multifunction Biquad filter configuration has more advantageous features such as low active and passive sensitivities, low power supply voltage, low power consumption, low quality factor, very low power consumption, more electronic tunability, higher linearity and required small area of the chip. The performance of the proposed configuration has been verified through PSPICE simulation using 0.18 μ m CMOS Technology process parameters.

Keywords:-Transadmittance Mode (TAM), Voltage Differencing Transconductance Amplifier (VDTA), CMOS Technology.

Received: November 18, 2020. Revised: April 16, 2021. Accepted: May 10, 2021. Published: May 21, 2021.

1. Introduction

Now a day's in the new field of analog signal processing as well as digital signal processing and circuit design applications such as voice decoding, encoding, control system and image processing in the realization of oscillators, continuous time filter and active filters. These filtering applications have become very popular research areas. Transadmittance Mode is mainly used for realizing analog filters which is required voltage signal at the input and provides currents at the output. Transadmittance Mode can be presented as the interfacing of filter circuits connecting voltage mode to current mode in large number of applications namely receiver base band blocks of modern radio system where the conversion of voltage signal into current signal is needed. In the present age VDTA, VDVTA, VDIBA, VDBA, DVCC are considered a most popular universal

active building block with wide applications in voltage mode, current mode, transadmittance mode, transimpedance mode and mixed signal processing. A large number of advantageous future trends can be found in the realization of active filters and oscillators with the of these universal active building blocks such as reducing power supply voltage , power consumption and physical size of integrated circuits in the transition to mixed signal processing.

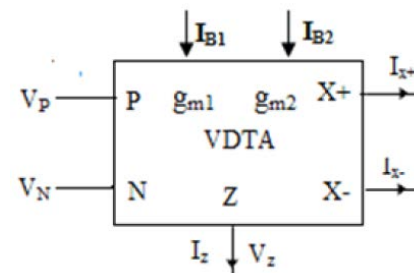

Figure.1. Symbolical Representation of VDTA

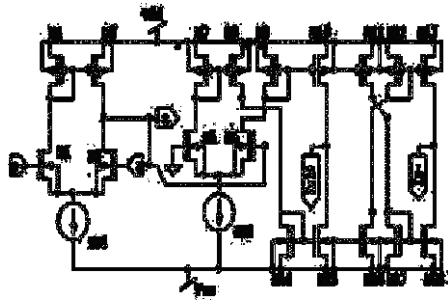

Figure.2. CMOS Realization of the proposed VDTA based TAM type Biquad filter configuration

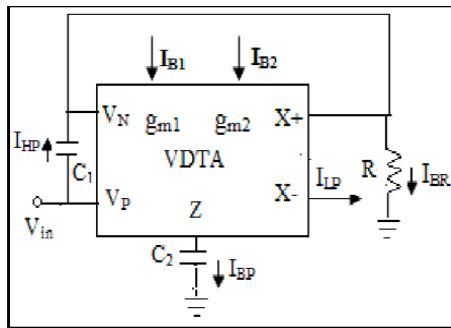

Figure.3. Proposed TAM Biquad Filter Configuration

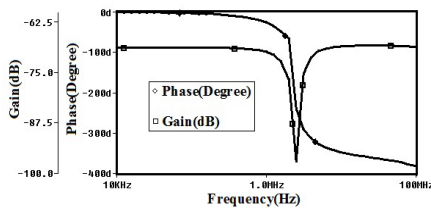

Figure.4. CMOS Simulated Phase and Gain responses of Band Reject Filter

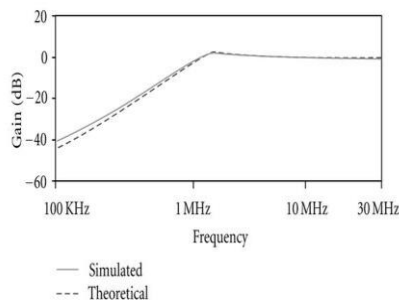

Figure.5 CMOS Simulated Gain and Phase Response of High Pass Filter

Where P and N are the input terminals presents high impedance. The terminals X⁺, X⁻ and Z are the output terminals are also having high impedance. The terminal relationship of an ideal VDTA can be described in equation (1).

$$\begin{bmatrix} I^{X^\pm} \\ I^Z \end{bmatrix} = \begin{bmatrix} 0 & 0 & \pm g_{m2} \\ g_{m1} & -g_{m1} & 0 \end{bmatrix} \begin{bmatrix} V_N \\ V_Z \\ V_P \end{bmatrix} \quad (1)$$

Where g_{m1} , g_{m2} the transconductance of first stage and second stages of VDTA which are controlled with the help of different bias currents I_{B1} and I_{B2} of VDTA. The Mathematical realization of g_{m1} and g_{m2} can be described in equations (2a),(2b),(2c) are respectively of proposed configuration.

$$g_i = \sqrt{\left(\frac{W}{L}\right) I_{Bi} \mu_n C_{ox}} \quad (2a)$$

$$g_{m1} = \sqrt{\left(\frac{W}{L}\right) I_{B1} \mu_n C_{ox}} \quad (2b)$$

$$g_{m2} = \sqrt{\left(\frac{W}{L}\right) I_{B2} \mu_n C_{ox}} \quad (2c)$$

Whereas μ_n is the charge carrier mobility of the NMOS Transistors and C_{ox} is the gate oxide Capacitance per unit area $\left(\frac{W}{L}\right)$ is the aspect ratio of the NMOS transistors. CMOS Realization of the proposed VDTA based TAM type Biquad filter configuration is shown in figure.2.

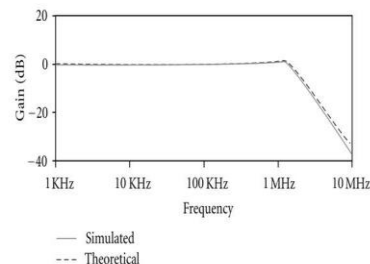

Figure.6. CMOS Simulated Gain and Phase Response of Low Pass Filter

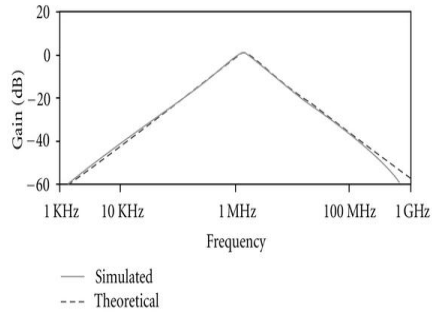

Figure.7. CMOS Simulated Gain and Phase Response of Band Pass Filter

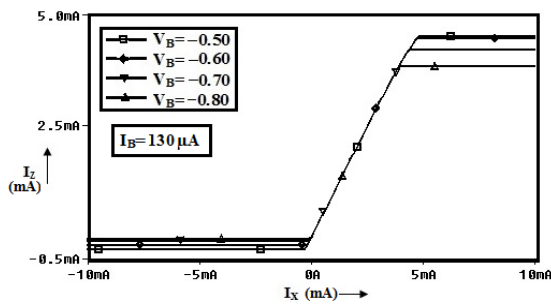

Figure.8 (a) Transient response for I_{X+} and I_z at different V_B and $I_B=130\mu A$

2. Literature Review

In the reported literature the transadmittance mode Biquad configurations are available to design both multi input single output or single input multi output on the basis of input and output signals presents in the circuits. The reported multi input single output (MISO) type structure has major drawback over the single input multi output (SISO) type structure. MISO type structure needs multiple input signals further required additional hardware to implement multiple input for realizing single filter function at a time while single input multi output (SISO) type structure need only single input signal and realize more than one filter functions respectively. In the reported literature some current mode and transadmittance mode are presented such as Mohammad Faseehuddin worked on Electronically Tunable Mixed Mode Universal Filter Employing a Single Active Block and Minimum number of Passive Components[1], Data R.Bhaskar presented Mixed Mode Universal Biquad Filter Using OTAs[2], Ghanshyam. Singh presented VDTA Based Electronically tunable wave active filter[3], Ghanshyam. Singh worked on VVDTA and OTA Based fully Electronically tunable first order all pass filter[4], Sajai.V.Singh presented A Novel

3. Analysis of Proposed Tam Type Biquad Filter Configuration

The proposed VDTA based TAM type Biquad filter configuration is shown in figure.3. Proposed VDTA based TAM type Biquad filter configuration employed single VDTA, one grounded resistor and two capacitors one of the capacitor is grounded. The transfer function can be observed through the analysis of the proposed VDTA based TAM type Biquad filter configuration. Transfer functions of Transadmittance Mode Biquad Low Pass Filter and Band Reject filter, High Pass Filter, Band Pass Filter and All Pass Filter can be presented in equation (3a),(3b),(3c),(3d):

$$\left[\frac{I}{V_{in}} \right]_{LPF} = \frac{\frac{g_{m1}g_{m2}}{RC_1C_2}}{S^2 + \frac{S}{RC_1} + \frac{g_{m1}g_{m2}}{C_1C_2}} \quad (3a)$$

$$\left[\frac{I}{V_{in}} \right]_{BRF} = \frac{\frac{1}{R} \left(S^2 + \frac{g_{m1}g_{m2}V_{in}}{C_1C_2} \right)}{S^2 + \frac{S}{RC_1} + \frac{g_{m1}g_{m2}}{C_1C_2}} \quad (3b)$$

$$\left[\frac{I}{V_{in}} \right]_{HPF} = \frac{\frac{S^2}{R}}{S^2 + \frac{S}{RC_1} + \frac{g_{m1}g_{m2}}{C_1C_2}} \quad (3c)$$

$$\left[\frac{I}{V_{in}} \right]_{BPF} = \frac{\frac{Sg_{m1}}{RC_1}}{S^2 + \frac{S}{RC_1} + \frac{g_{m1}g_{m2}}{C_1C_2}} \quad (3d)$$

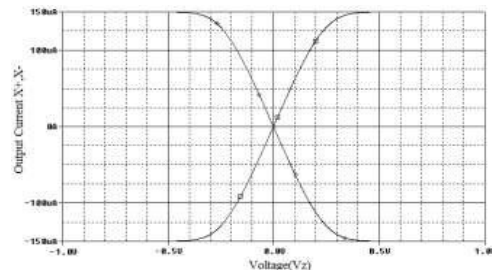

Figure.8 (b) DC Transfer Characteristics for I_{X+} and I_{X-} at different V_z .

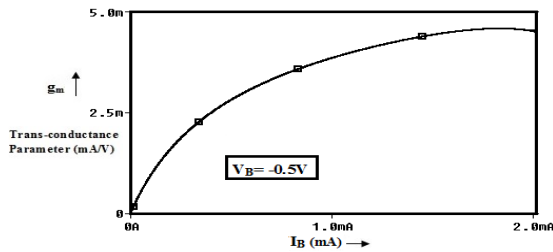

Figure.9. Transconductance (g_m) variation at different values of bias currents (I_B)

electronically tunable universal mixed mode biquad filter[5], S.V.Singh worked on MCCTA based single input three output Electronically tunable current mode active C Biquad filter[6], Gunjan.Gupta presented VDTA Based Electronically Tunable Voltage Mode and Trans admittance Mode Biquad Filter [7], Dinesh Prasad worked on Universal Current Mode Biquad Filter using a VDTA[8], D.Prasad presented trans admittance type universal current mode Biquad filter using VDTAs[9], J. Satansup presented Electronically Tunable Single Input Five-Output Voltage-Mode Universal Filter Using VDTAs[10], N. Herencsar worked on four phase oscillator employing only single Z-copy VDTA[11], J. Satansup presented Single VDTA-based current-mode electronically tunable multifunction filter[12], A.Yesil worked on New simple CMOS realization of voltage differencing transconductance amplifier and its RF filter application[13], S.V.Singh presented on An Electronically tunable SIMO Biquad filter using CCCCTA[14]M.Siripruchyanun worked on CMOS current-controlled current differencing transconductance amplifier and applications to analog signal processing[15],S.Maheshwari presented on High performance voltage-mode multifunction filter with minimum component count[16], N.A.Shah worked on “CDTA based universal trans admittance filter[17], Ü. Keskin worked on Current-mode KHN filter employing current differencing trans conductance amplifiers[18], D. R. Bhaskar worked on New OTA-C universal current-mode/trans- admittance biquad[19], Muhammad.Taher presented A Novel Mixed Mode CCII Based Filter[20], N.A.Shah presented SISO high output impedance trans admittance filter using FTFNs [21],] A. Toker worked on High output impedance trans-admittance type continuous time multifunction filter [22].

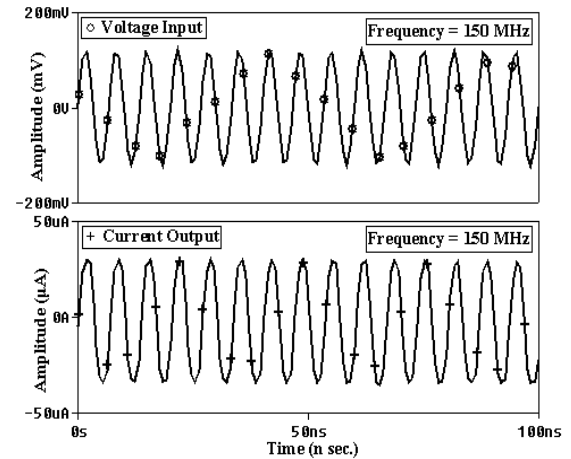

Figure.10. Simulated AC Transient Response of Input 100mV peak to peak and Output 400 mV peak to peak at frequency = 150MHz

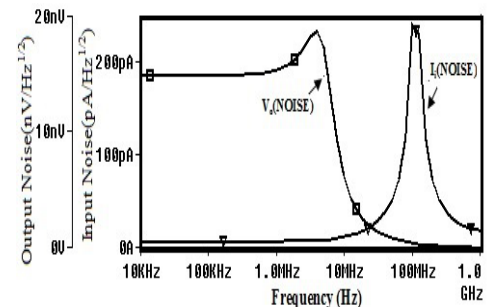

Figure.11. Simulated Spectral Density for Input Output Noise of TAM type Biquad Low Pass Filter

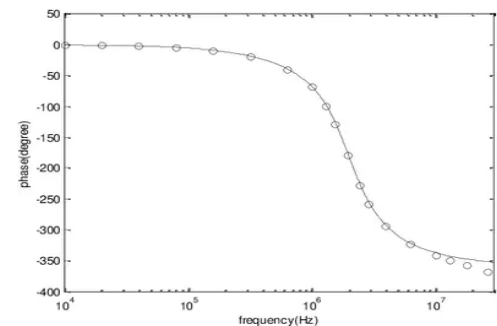

Figure.12. Phase vs Frequency Responses of the proposed TAM in mixed mode with All pass Filter

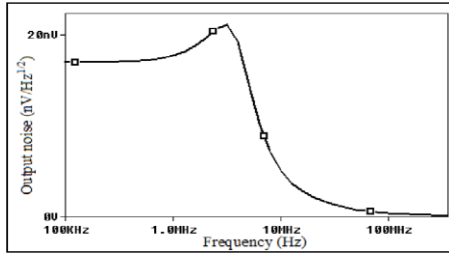

Figure.13. Simulated output Noise

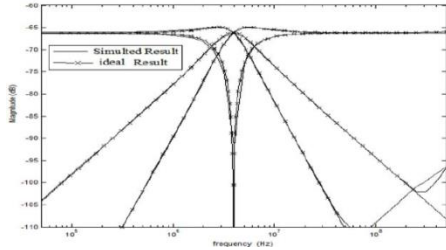

Figure.14. Simulated and ideal Response of LPF, HPF, BPF, BRF

Table.1: Aspect Ratios of MOS Transistors

NMOS Transistors	W(μm)	L(μm)
M1,M2,M5,M6	8.24	0.36
M3,M4,M7,M8	4.33	0.36
M9 – M18	7.0	0.36

4. Non Ideal Effect and Sensitivity Performance

In this stage non ideal effect and sensitivity performance of VDTA based TAM type Biquad filter configuration has been tested through PSPICE simulation using CMOS 0.18μm Technology process parameters. The non ideal effect of VDTA occurs due to mismatching of MOS Transistors in the CMOS realization on the performance of the proposed VDTA based TAM type Biquad filter configuration is considered. We considered non ideal errors of VDTA. The current and voltage relationship between input & output Port of VDTA based TAM type Biquad Filter Configuration can be realized by equation (4):

$$\begin{bmatrix} I_{X\pm} \\ I_Z \end{bmatrix} = \begin{bmatrix} 0 & 0 & \pm \beta_2 g_{m2} \\ \beta_1 g_{m1} & -\beta_1 g_{m1} & 0 \end{bmatrix} \begin{bmatrix} V_Z \\ V_N \\ V_P \end{bmatrix} \quad (4)$$

Transfer function of the high pass and low pass filter due to tracking errors of the VDTA based TAM Biquad filter configuration can be employed as by equation (4a) and (4b):

From the transfer function of the proposed VDTA based TAM type Biquad is presented TAM type low pass filter, high pass filter, band pass filter and band reject filter responses. The characteristic parameters for the proposed configuration in terms of pole frequency (ω_0), Electronic tunability Conditions for the proposed VDTA based TAM type Biquad Configuration $g_{m1} = g_{m2} = g_m$ and $C_1 = C_2 = C$. Quality factor (Q_0) can be tuned independently with the help of g_{m1} without changing Pole Frequency.

$$\text{Pole Frequency } (\omega_0) = \sqrt{\frac{g_{m1}}{C}} \text{ Where } R = \frac{1}{g_{m1}} \text{ and}$$

$$\text{Quality factor } (Q_0) = \frac{1}{g_{m1}}$$

The pole frequency and Quality factor of the proposed configuration are described as in equation(3e) and (3f) :

$$(\omega_0) = \sqrt{\frac{g_{m1}g_{m2}}{C_1C_2}} \quad (3e)$$

$$Q_0 = R \sqrt{gm_1 gm_2 \left(\frac{C_1}{C_2} \right)} \quad (3f)$$

Therefore it is clear from the pole frequency (ω_0) can be tuned electronically and independent of Quality factor (Q_0) with the proper selection of transconductance $gm_1 gm_2 = \frac{1}{R}$ tuned independently with the help of g_{m1} without changing Pole Frequency. Therefore it is clear from the theoretical analysis of the characteristic parameters for the proposed configuration the of pole frequency (ω_0) can be tuned electronically and independent of Quality factor (Q_0) with the proper selection of transconductance $gm_1 gm_2 = \frac{1}{R}$.

$$\left[\frac{I}{V_{in}} \right]_{HPF} = \frac{\frac{S^2}{R}}{S^2 + \frac{S}{RC_1} + \frac{\beta_1 \beta_2 g_{m1} g_{m2}}{C_1 C_2}} \quad (4a)$$

$$\left[\frac{I}{V_{in}} \right]_{LPF} = \frac{\frac{\beta_1 \beta_2 g_{m1} g_{m2}}{RC_1 C_2}}{S^2 + \frac{S}{RC_1} + \frac{\beta_1 \beta_2 g_{m1} g_{m2}}{C_1 C_2}} \quad (4b)$$

Transfer function of the band pass and band reject filter due to tracking errors of the VDTA based TAM Biquad filter configuration can be employed by equation (4c) and (4d) :

$$\left[\frac{I}{V_{in}} \right]_{BPF} = \frac{\frac{S \beta_1 g_{m1}}{RC_1}}{S^2 + \frac{S}{RC_1} + \frac{\beta_1 \beta_2 g_{m1} g_{m2}}{C_1 C_2}} \quad (4c)$$

$$\left[\frac{I}{V_{in}} \right]_{BRF} = \frac{\frac{1}{R} \left(S^2 + \frac{\beta_1 \beta_2 g_{m1} g_{m2}}{C_1 C_2} \right)}{S^2 + \frac{S}{RC_1} + \frac{\beta_1 \beta_2 g_{m1} g_{m2}}{C_1 C_2}} \quad (4d)$$

From the analysis of the tracking errors of the VDTA based TAM Biquad filter configuration to observe characteristic parameters.

Pole frequency (ω_0) due tracking errors of the VDTA based TAM Biquad filter configuration can be employed Pole frequency (ω_0), Quality factor (Q_0) and Bandwidth (BW) as by equation (5a), (5b) and (5c) respectively

$$(\omega_0) = \sqrt{\frac{\beta_1 \beta_2 g_{m1} g_{m2}}{C_1 C_2}} \quad (5a)$$

$$(Q_0) = R \sqrt{\frac{\beta_1 \beta_2 g_{m1} g_{m2}}{C_2}} \quad (5b)$$

$$(BW) = \frac{1}{RC_1} \quad (5c)$$

Table.2: Comparative Analysis of TAM type Biquad Filter Configuration

Ref No	No of Active Components	No of Passive Components	Realizable Filter Structures	No of floating Components	Electronic Tunability	Input Voltage at High Impedance Terminals
3	1 MCCTA	2C	LP,HP.BP,BR, AP	NIL	Yes	No
4	2 VDTA	2C	LP,HP.BP,BR, AP	2C	Yes	Yes
5	1 VDTA	2C	LP,HP.BP, BR, AP	NIL	Yes	Yes
6	2 VDTA	2C,1R	LP,HP.BP,BR, AP	NIL	Yes	Yes
11	2 CCCCTA	3C	LP,HP.BP	NIL	Yes	No
12	5 CCH	2C,7R	LP,HP.BP,BR,AP	7R	No	No
13	4 OTA	2C	LP,HP.BP	NIL	Yes	Yes
18	3 PFTFN	3R,2C	LP,HP.BP	2R,2C	No	No
19	3CCH	3R,2C	LP,HP.BP	2C,2R	No	No
Proposed	1 VDTA	1R,2C	LP,HP.BP,BR	1C	Yes	Yes

Table 3: Simulated Parameters of Proposed VDTA based TAM Biquad Filter at Bias Current $I_{Bias} = 60 \mu A$

S.No	Specifications	Simulated
1	CMOS Technology	0.18 μm
2	Bias Voltage (V)	± 0.50 V
3	Power Supply Voltage (V)	$V_{DD} = -V_{SS} \pm 0.60$ V
4	Transconductances ($\mu A/V$)	$g_{m1}=g_{m2}=492.50 \mu A/V$ at $54\mu A$ $I_{B1}= I_{B2}= 54 \mu A$ s
5	Bias current (μA)	10 μA , 20 μA ,30 μA ,60 μA ,130 μA
6	% Total Harmonic Distortion	2.68 – 3.03 % for sinusoidal signal at 400-500 KHz
7	Power Consumption (mW)	0.896 - 0.998 mW
8	Maximum output noise (nV)	20.97 – 22.65 nV / \sqrt{Hz}
9	Phase Margin	50 deg
10	Offset Voltage (mV)	5 mV
11	Slew Rate (V / μs)	64.33 V/ μs - 77 V/ μs
12	DC Gain (dB)	98 dB
13	Common Mode Rejection Ratio	65 – 90 dB
14	Electronic Tunable Range for Simulated Pole Frequencies	3.98MHz, 4.31MHz,6.28MHz ,10.397MHz– 11.98MHz at Proper Selection of Resistance values 1.32 K Ω -2.2K Ω and with the selection capacitance values of 10 pf - 0.001 nf

5. PSPICE Simulation Results

PSPICE simulations of the proposed VDTA based TAM type Biquad filter configuration are performed using CMOS realization of VDTA in 0.18 μm CMOS technology parameters. Power supply voltage and different biasing currents are taken as $V_{DD} = -V_{SS} = \pm 0.6V$, $V_B = 0,5V$ and $I_B = 10 \mu A$, 20 μA , 30 μA , 60 μA , 130 μA . To achieve $I_{B1} = I_{B2} = 54\mu A$ and $g_{m1} = g_{m2} = 492.50\mu A/V$ with selection of the passive component values are as $R = 1.32 K\Omega$, 2.2K Ω , $C1 = C2 = 10pF$, 0.001nf. The aspect ratios of various MOS transistors are given in Table. 1. The CMOS simulated phase and gain responses of the Band Reject filter , High pass filter, Low pass and band pass filters for the proposed TAM type VDVTA based Biquad filter configuration is shown respectively in the figure 4,figure.5,figure.6 and simulated phase and gain response of band pass filter in figure.7.

5.1 Observe Transient Responses

The transient response for I_{X+} and I_z of the proposed Transadmittance Mode type VDTA based Biquad filter are shown in figure .8(a) at different V_B and $I_B = 130\mu A$. $V_B=0.5V$ and $I_B=130\mu A$ and DC transfer characteristics in figure.8 (b) for I_{X+} and I_X . At different V_z .The transconductance (g_m) variation at different values of bias currents (I_B) with bias voltage $\pm 0.5V$ is shown in figure.9.The simulated AC transient response is shown in figure.10. The simulated transient response of the proposed configuration is employed by applying input signal peak to peak 100mV-400mV. The simulated transient response at 130 MHz - 150MHz for input and the output stage of VDTA is presented with 2.2 K Ω load resistor which is connected across the low pass filter. The aspect ratios of various MOS transistors are given in Table. 1. The electronic tuning capability range of the proposed circuit in term of pole frequency (F0) variation 3.98 MHz , 4.31MHz, 6.28MHz is shown in figure.11, phase - frequency of proposed TAM Biquad filter in mixed mode with all pass signals is presented in figure.12, From the simulated and ideal responses of the proposed TAM Biquad filter is verified

the simulated value of the pole frequency is obtained as 11.98 MHz which is nearly same as the calculated value of 12.02 MHz with the proper selection of the values of the passive component $C_1 = C_2 = 0.001\text{nf}$ and $R = 1.32\text{ K}\Omega$ to achieve DC transfer characteristics is the same at the input and output stages of the VDTA. The electronic tuning capability range of the proposed TAM Biquad filter in term of pole frequency (F0) variation 3.98 MHz, 4.31MHz, 6.28MHz, 10.397MHz and 11.98MHz also presented which is independent of quality factor (Q_0).

5.1.1. Simulated Output Noise

The simulated output noise of the proposed TAM Biquad filter is shown in figure.13 and PSPICE simulation of TAM type Biquad filter gain responses of low pass, high pass, band pass and band reject or band stop filter responses of the proposed VDTA based TAM type Biquad filter is presented in figure.14. Comparative Analysis of TAM type Biquad Filter Configuration are given in table 2 and the Simulated Parameters of Proposed VDTA based TAM Biquad Filter at Bias Current $I_{\text{Bias}} = 54\ \mu\text{A} - 60\ \mu\text{A}$ are given in table 3.

5.1.2. Active and Passive Sensitivity Analysis

The active and passive sensitivity is the important parameters of the filter configuration The active and passive sensitivities of ω_0 and Q_0 for the proposed configuration are characterized as :

$$S_{C_1}^{Q_0} = \frac{1}{2}, \quad S_{C_2}^{Q_0} = -\frac{1}{2}, \quad S_R^{Q_0} = 1, \quad S_{C_1 C_2}^{Q_0} = -\frac{1}{2}$$

$$, \quad S_{\beta_1 \beta_2}^{\omega_0} = \frac{1}{2}, \quad S_{g_m g_{m_2}}^{\omega_0} = \frac{1}{2}$$

$$, \quad S_{C_1}^{Q_0} = \frac{1}{2}, \quad S_{C_2}^{Q_0} = -\frac{1}{2}, \quad S_R^{Q_0} = 1, \quad S_{C_1 C_2}^{\omega_0} = -\frac{1}{2}$$

$$, \quad S_{\beta_1 \beta_2}^{\omega_0} = \frac{1}{2}, \quad S_{g_m g_{m_2}}^{\omega_0} = \frac{1}{2}$$

From the active and passive sensitivity analysis ω_0 and Q_0 are less than unity for the proposed VDTA based TAM Biquad filter configuration. It yields sensitivity performance is excellent. The filter parameters such as pass band gain, quality factor and pole frequency may slightly altered due to the effects of tracking errors β_1, β_2 . Where β_1 and β_2 are the tracking errors of the first stage and second stage of the VDTA From the analysis of the tracking errors of the VDTA based TAM Biquad filter configuration to observe various transfer function and characteristic parameters.

6. Performance Evaluation

The performance evaluation of the proposed VDTA based TAM Biquad filter is taken from TMS320C18 CMOS technology parameters. Proposed VDTA based mixed mode configuration can be used as analog active audio filter in audio system, loudspeakers, modern biomedical devices and speech processing. It also plays major role for the measuring Frequency and phase response of the in the all field of the Telecommunication at the desirable pole frequency ranges.

7. Conclusion

VDTA based TAM type Biquad filter configuration realized in this paper employs single VDTA, one grounded resistor and two capacitors one of the capacitor is grounded to realize standard second order four filter responses. PSPICE simulations confirm the functionality and workability of the Proposed TAM type Biquad filter configuration with the selection the values

of $R = \frac{1}{g_m}$. For the simulating various TAM type

Biquad filter band pass filter at constant (Q_0) = 1. In this paper we have made an effort in designing biquad filter using VDTA that can be helpful in getting accurate response for realizing all five standard filters in mixed biquad filter. VDTA based TAM type Biquad filter configuration presents some of the following advantageous features:

- [1] Availability of Transadmittance filter output responses yields high output impedance.
- [2] Realizations of all five standard filters are easily using only two MOS transistors with the use of grounded resistor.
- [3] Active and passive sensitivities are less than unity.
- [4] Two input peak to peak voltages provide the high impedances at the input port.
- [5] It offers electronic tunability of pole frequency (ω_0) and independent of quality factor (Q_0) with the simultaneous variations in the transconductance of the VDTA.
- [6] It yields very low power consumption of 0.986mW - 0.998mW.
- [7] VDTA as a single active element, one grounded resistor and two capacitors one of the capacitor is grounded.
- [8] Operating at low power supply $\pm 0.6\text{V}$.
- [9] The proposed configuration does not required component matching conditions.
- [10] In Future the proposed configuration can be in mixed mode analog signal processing at very low operating voltage.
- [11] Ability to operate in all four modes for realizing all five filtering responses.
- [12] The proposed mixed configuration yields low output impedance in voltage mode.
- [13] The proposed mixed configuration yields high output impedance in current mode and transadmittance mode..

References

- [1] Mohammad Faseehuddin, Norbert Herencsar, Musa Ali Albme and Jahariah Sampe(2021) ,“ Electronically Tunable Mixed Mode Universal Filter Employing a Single Active Block and Minimum number of Passive Components,” Appl.Sci11,55,https://dx.doi.org/10.3390/app11010055
- [2] Data R.Bhaskar, Ajishek Raj, Pragati(2020) ,“ Mixed Mode Universal Biquad Filter Using OTAs,” Journal of Circuits , Systems and Computers,vol.29,No.10,2050162,https://doi.org/10.1142/S0218126620501625
- [3] Ghanshyam. Singh(2020) ,“CMOS Realization of VDTA Based Electronically tunable wave active filter with minimum power consumption at low supply voltage ± 0.82 V,” Circuit and System, DOI:10.4236/cs2020.112002, Vol. 11, pp. 11-26.
- [4] Ghanshyam. Singh(2020) ,“CMOS Realization of VVDTA and OTA Based fully Electronically tunable first order all pass filter with optimum linearity at low supply voltage ± 0.85 V,” Circuit and System, DOI:10.4236/cs2020.114004, pp. 39-49.
- [5] Sajai.V.Singh,Ravindra. Singh. Tomar,DS.Chauhan(2016),“ A Novel electronically tunable universal mixed mode biquad filter,” JER,4(2),pp.44-64, http://dx.doi.org/10.7603/s40632-016-0013-3.
- [6] S.V.Singh,R.J.Tomar,D.S.Chauhan(2015) , “ Single MCCTA based single input three output Electronically tunable current mode active C Biquad filter,” ICSC,DOI:10.1109/ISCPCCom2015.7150660.
- [7] Gunjan.Gupta,Sajal.Vir.Singh,Sunil, Vidya.Bhooshan(2015) , “ VDTA Based Electronically Tunable Voltage Mode and Trans admittance Mode Biquad Filter,”circuit and system,6,pp.99-102.
- [8]D.Prasad,M.Srivastava and D.R.Bhaskar(2014), “ trans admittance type universal current mode Biquad filter using VDTAs,”International scholarly Research , Article ID 762845pp. 1 -4.
- [9] Dinesh.Prasad,Data.Ram.Bhaskar and Mayank.Srivastava (2013), “Universal Current Mode Biquad Filter using a VDTA,” circuit and system,pp.29-33, http://dx.doi.org/10.4236/cs.2013.41006
- [10]J. Satansup, T. Pukkalanun and W. Tangsrirat(2013), “Electronically Tunable Single- Input Five-Output Voltage-Mode Universal Filter Using VDTAs and Grounded Passive Elements,” Circuits, Systems, and Signal Processing,Vol. 32, Issue 3, pp 945-957.
- [11]N. Herencsar, R. Sotner, J. Koton, J. Misurec and K. Vrba(2013), “New compact VM four phase oscillator employing only single Z-copy VDTA and all grounded passive elements,”Electron. Electric. Eng.19 (10), pp. 87-90.
- [12]J. Satansup and W. Tangsrirat(2012), “Single VDTA based current-mode electronically tunable multifunction filter,” in Proceedings of the I-SEEC, Petchburi,Thailand, pp.266-272.
- [13]A.Yesil, F. Kacar and H. Kuntman(2011), “New simple CMOS realization of voltage differencing transconductance amplifier and its RF filter application,” Radioengineering, vol. 20, no. 3, pp. 632- 637.
- [14]S. V. Singh, S. Maheshwari, J.Mohan and D. S. Chauhan(2009),“ An Electronically tunable SIMO Biquad filter using CCCCTA,” CCIS, Vol. 40, pp. 544 -554.
- [15]M.Siripruchyanun, W.Jaikla(2008), “CMOS currentcontrolled current differencing transconductance amplifier and applications to analog signal processing,” AEU-Int. J. Electron.Commun.,Vol.62, pp. 277-287.
- [16]S. Maheshwari(2008), “High performance voltage mode multifunction filter with minimum component count,” WSEAS Transactions on Electronics, Vol. 5, pp. 244-249.
- [17]N.A.Shah,M.Quadri and S.Z.Iqbal(2007), “CDTA based universal trans admittance filter ,” AIC and signal processing, Vol. 52, pp.65-69.
- [18] Ü. Keskin, D. Biolek, E. Hancioglu and V.Biolkova(2006),“Current-mode KHN filter employing current differencing trans conductance amplifiers,”Int’l.J.Electronics and Communications (AEÜ), Vol. 60, pp. 443-446.
- [19]D. R. Bhaskar, A. K. Singh, A. K. Sharma and R. Senani(2005), New OTA-C universal current mode/ trans-admittance biquads, IEICE Electronics Express, Vol. 2, pp. 8-13.
- [20]Muhammad.Taher,Abuelmatti and Abdulwahab. Bentreia(2004), “A Novel Mixed Mode CCII Based Filter,” Active and Passive Electronic Components, Vol. 27, pp. 197-205.
- [21] N.A.Shah, S.Z.Iqbal and Parveen(2004),“SISO high output impedance trans admittance filter using FTFNs,”AIC and Signal Processing, Vol. 40, pp. 87 - 89.
- [22] A. Toker, O. Çiçekoglu, S. Özcan and H. sKuntman(2001), High output impedance transadmittance type continuous time multifunction filter with minimum active elements, Int’l J. Electronics, Vol. 88, No. 10, pp. 1085-1091.

Contribution of Individual Authors to the Creation of a Scientific Article (Ghostwriting Policy)

The authors equally contributed in the present research, at all stages from the formulation of the problem to the final findings and solution.

Sources of Funding for Research Presented in a Scientific Article or Scientific Article Itself

No funding was received for conducting this study.

Conflict of Interest

The authors have no conflicts of interest to declare that are relevant to the content of this article.

Creative Commons Attribution License 4.0 (Attribution 4.0 International, CC BY 4.0)

This article is published under the terms of the Creative Commons Attribution License 4.0

<https://creativecommons.org/licenses/by/4.0/deed.en>