

A novel approach for analog circuit incipient fault diagnosis by using kernel entropy component analysis as a preprocessor

CHAO-LONG ZHANG

School of Physics and Electronic Engineering
Anqing Normal University
No. 128, Lin Hu Nan Road, Anqing 246011
PEOPLE'S REPUBLIC OF CHINA
zhangcl@aqtc.edu.cn

CHAO-LONG ZHANG, YI-GANG HE, LI-FEN YUAN and WEI HE

School of Electrical Engineering and Automation
Hefei University of Technology
No. 193, Tun Xi Road, Hefei 230009
PEOPLE'S REPUBLIC OF CHINA

Abstract: - In order to diagnose incipient fault of analog circuits effectively, an analog circuit incipient fault approach by using kernel entropy component analysis (KECA) as a preprocessor is proposed in the paper. Time responses are acquired by sampling outputs of the circuits under test. Raw features with high dimension are generated by wavelet transform. Furthermore, lower dimensional features are produced through KECA as samples which are used to construct a classification model based on least squares support vector machine. Bandpass filter and leapfrog filter incipient fault diagnosis simulations demonstrate the diagnose procedure of the proposed approach, and also validate proposed approach by using KECA as a preprocessor can produce higher diagnosis accuracy than the commonly used methods.

Key-Words: - Analog circuits, Incipient fault diagnosis, Wavelet transform, KECA, Least squares support vector machine

1 Introduction

Analog circuits are widely used in many electronic systems such as home electronics, automotive electronics, industrial electronics, military electronics, etc. Meanwhile, analog circuit fault diagnosis has become an active area of research in recent years. However, compared to the well investigated fault diagnosis of digital electronic circuits, the diagnostics of analog circuits is far fall behind for the reason of component tolerance effects, insufficient information, and analog circuits' nonlinearity.

Feature extraction is a first important problem in analog circuit fault diagnosis, which produces a strong effect on successive classifier's efficiency [1-17]. The work in [2] used impulse responses of analog circuits as features, which led to a tremendous computing workload of classifier. Wavelet transform was proposed to dispose impulse responses and generate high dimensional features [3-7]. Meanwhile, principal component analysis (PCA) [3-6], kernel principal component analysis (KPCA) [7], linear discriminant analysis (LDA) [8] and kernel linear discriminant analysis (KLDA) [9] were presented to

reduce the dimension of high dimensional features in fault diagnosis, and positive results were acquired [3-9].

Classifier selection is another critical problem in analog circuit fault diagnosis. Artificial neural network has been commonly used for it can perform analog circuit fault diagnosis by using the extracted performance data [10-12]. However, low convergence rate, falling local optimal solution, and poor generalization are disadvantages of the algorithm. Support vector machine (SVM) is a machine learning tool [18] that accounts for the trade-off between learning ability and generalizing ability by minimizing structure risk, and it has been utilized to analog circuit fault diagnosis [13, 14]. Least squares support vector machine (LSSVM) improves SVM formulation by adopting least-squares linear system as the loss function, which can significantly enhance the performance and reduce the computation complexity [19]. Hence, LSSVM is employed to construct classification model in many recent works [15-17].

Most of the above works focus on the analog

circuit fault diagnosis, and incipient fault diagnosis attracts few attentions. However, identifying the incipient fault and maintaining the faulty component timely is conducive to the health of analog circuits and avoid developing into a catastrophic failure of analog circuits. Kernel entropy component analysis (KECA) is a spectral approach based on the kernel similarity matrix and it manages to maintain maximum Renyi entropy of the input space data set [20]. In this paper, a novel approach for analog circuit incipient fault diagnosis by using KECA as a preprocessor is presented. Wavelet transform and KECA are used for feature extraction and dimension reduction. LSSVM is applied to classify different fault classes. The proposed approach is demonstrated by incipient fault diagnosis simulations of Sallen-Key bandpass filter and leapfrog filter. In addition, KECA is compared with KPCA in visualization, and also compared with PCA, KPCA and KLDA in diagnosis simulations.

This paper is organized in the following order: Section 2 introduces incipient fault diagnosis approach used in the work. Section 3 gives the simulation results and discussions. Finally, conclusions are drawn in Section 4.

2 Incipient fault diagnosis approach

Fault diagnosis approach is usually consisting of feature extraction, feature dimension reduction and classification model construction [2-9, 11, 12]. In the work, wavelet transform is used to produce raw features firstly, and then KECA is utilized to reduce the dimension of raw features. Finally, a classification model is constructed by using LSSVM.

2.1 Wavelet transform

Wavelet transform is an effective signal analysis technique, and it can generate sufficient features by using n -level wavelet decomposition. A mother wavelet $\psi(x)$ is defined firstly

$$\psi_{a,b}(x) = \frac{1}{\sqrt{a}} \psi\left(\frac{x-b}{a}\right) \quad (1)$$

where a and b are the scaling parameter and translating parameter, respectively.

Assuming $f(x)$ is a signal, the wavelet transform of $f(x)$ is

$$c(a,b) = \langle f(x), \psi_{a,b}(x) \rangle = \frac{1}{\sqrt{a}} \int_{-\infty}^{+\infty} f(x) \psi\left(\frac{x-b}{a}\right) dx \quad (2)$$

where $c(a, b)$ are the wavelet coefficients of the $f(x)$.

The signal $f(x)$ can be decomposed into different levels of approximation coefficients and detail

coefficients which represent the low-frequency and high-frequency components of $f(x)$. For the reason of approximation coefficients can capture the basic structure of the signal, the first approximation coefficients of levels 1 to 5 are selected as raw features according to the classic works [3-5]. Haar function has short duration in time domain and discontinuous character which can cause distinct features for distinguishing across fault classes. Therefore, Haar wavelet is utilized to process the impulse responses of CUTs in the work.

2.2 KECA

Kernel entropy component analysis is a novel kernel based data transformation method. Compared to the widely used dimension reduction method KPCA which is based on top eigenvalues and eigenvectors of kernel matrix, KECA is on basis of kernel similarity matrix and it manages to maintain the maximum Renyi entropy of the input space data set.

Renyi quadratic entropy is defined as

$$H(p) = -\log \int p^2(x) dx \quad (7)$$

where $p(x)$ is probability density function producing data set $D = x_1, x_2, \dots, x_N$. Since the logarithm is a monotonic function, it can be quantified as $V(p) = \int p^2(x) dx$. A Parzen window density estimator is defined to estimate $V(p)$ and $H(p)$

$$\hat{p}(x) = \frac{1}{N} \sum_{x_u \in D} k_\sigma(x, x_u) \quad (8)$$

where $k_\sigma(x, x_u)$ is called Parzen window, or kernel function, and gauss kernel is used in the work.

Using the sample mean approximation of the expectation operator

$$\begin{aligned} \hat{V}(p) &= \frac{1}{N} \sum_{x_u \in D} \hat{p}(x_u) = \frac{1}{N} \sum_{x_u \in D} \frac{1}{N} \sum_{x_{u'} \in D} k_\sigma(x_u, x_{u'}) \\ &= \frac{1}{N^2} \mathbf{A}^T \mathbf{K} \mathbf{A} \end{aligned} \quad (9)$$

where element (u, u') of the $N \times N$ kernel matrix \mathbf{K} equals $k_\sigma(x_u, x_{u'})$ and \mathbf{A} is an $N \times 1$ vector of ones.

Renyi entropy estimator can be illustrated in the light of the eigenvalues and eigenvectors of the kernel matrix, which can be eigendecomposed as $\mathbf{K} = \mathbf{E} \mathbf{D}_\mu \mathbf{E}^T$, where \mathbf{D}_μ is a diagonal matrix consisting of eigenvalues $\mu_1, \mu_2, \dots, \mu_N$; \mathbf{E} is a matrix with columns are eigenvectors $\mathbf{e}_1, \mathbf{e}_2, \dots, \mathbf{e}_N$. $\hat{V}(p)$ can be expressed as

$$\hat{V}(p) = \frac{1}{N^2} \sum_{i=1}^N (\overline{\mu_i \mathbf{e}_i^T \mathbf{A}})^2 = \frac{1}{N^2} \sum_{i=1}^N \varepsilon_i \quad (10)$$

where each term ε_i contributes to the entropy estimate in the expression. The eigenvalues and eigenvectors which are the first v largest contribution to the entropy estimate are selected in KECA, then the v dimensional $\phi_{eca} = \mathbf{D}_v^{1/2} \mathbf{E}_v^T$, thus $\mathbf{K}_{eca} = \phi_{eca}^T \phi_{eca}$ can be obtained in the Mercer kernel space. This is obvious difference between KPCA and KECA.

2.3 LSSVM

LSSVM is an enhancement of the standard SVM. It uses a linear set of equations instead of a quadratic programming problem to obtain support vectors and adopts least-squares linear system as loss function. Consider a model in the primal weight space of the following form

$$y(x) = w^T \phi(x) + b \quad (11)$$

where $x_i \in R^N$ is the input and $y_i \in R$ is the output; $\phi(\cdot)$ maps the input data to a high dimensional feature space; w is an element of R^N . Combining fitting error and functional complexity, the optimization problem of LSSVM is substituted as

$$\min_{w,b,\xi} \frac{1}{2} w^T w + \frac{1}{2} c \sum_{i=1}^l \xi_i^2 \quad (12)$$

$$\text{s.t.} : \xi_i = y_i - [w^T \phi(x_i) + b] \quad \forall i=1,2,\dots,l \quad (13)$$

where c is penalty parameter and ξ_i is random error.

The Lagrangian of problem (12) is given by

$$L(w,b,\xi,a) = \frac{1}{2} w^T w + \frac{1}{2} c \sum_{i=1}^l \xi_i^2 - \sum_{i=1}^l a_i \{y_i - [w^T \phi(x_i) + b] - \xi_i\} \quad (14)$$

where a_i are Lagrange multipliers. The equation is solved by partially differentiating with respect to each variable

$$\begin{cases} \frac{\partial L}{\partial w} = 0 \Rightarrow w = \sum_{i=1}^l a_i \phi(x_i) \\ \frac{\partial L}{\partial b} = 0 \Rightarrow \sum_{i=1}^l a_i = 0 \\ \frac{\partial L}{\partial \xi_i} = 0 \Rightarrow a_i = c \xi_i \quad \forall i=1,2,\dots,l \\ \frac{\partial L}{\partial a_i} = 0 \Rightarrow \xi_i = y_i - [w^T \phi(x_i) + b] \quad \forall i=1,2,\dots,l. \end{cases} \quad (15)$$

After elimination of the variables w and ξ , the equation can be rewritten as a linear function group

$$\begin{pmatrix} K + c^{-1}I & \bar{\mathbf{1}}^T \\ \bar{\mathbf{1}} & 0 \end{pmatrix} \begin{pmatrix} a \\ b \end{pmatrix} = \begin{pmatrix} Y \\ 0 \end{pmatrix} \quad (16)$$

where $K_{ij} = k(x_i, x_j)$; $Y = [y_1, \dots, y_l]^T$; $\alpha = [\alpha_1, \dots, \alpha_l]^T$ and $\bar{\mathbf{1}} = [1, \dots, 1]$.

The LSSVM model can be obtained as

$$y(x) = \sum_{i=1}^l a_i k(x_i, x_j) + b \quad (17)$$

where a_i, b are solutions of the linear system; $k(x_i, x_j)$ is a kernel function which follows Mercer's theory. RBF kernel has powerful nonlinearity mapping ability, and it is selected as the kernel function in the work.

Because the LSSVM is a binary classifier and analog circuit incipient fault diagnosis is a multi-class recognition problem, one-against-rest (OAR), one-against-one (OAO) and binary tree method are commonly used in the LSSVM multi-classification. However, for a u -class problem, OAO method needs to constitute $u*(u-1)/2$ LSSVM classifiers which consumes too many computing resources. Meanwhile, OAR method is somewhat less accuracy. Binary tree method only needs to construct $u-1$ LSSVM classifiers, and it has the advantages of efficient computation of the tree architecture and high classification accuracy of LSSVMs. Hence, binary tree method is selected to solve the multi-class problem in the work.

3 Simulations and results

3.1 Simulation procedures and settings

In this section, Sallen-Key bandpass filter and leapfrog filter are used as example circuits. The input is a single pulse of height 10V with 1us duration. Tolerances of the resistors and capacitors are set to 5%. Generally, a component with 50% deviation from its nominal value is considered to be a fault [2-17]. Hence, the component with 25% deviation from its nominal value is regarded as an incipient fault in the work. Time impulse responses of different fault classes are acquired by sampling the outputs of the CUTs firstly, and then wavelet transform is employed to perform 5-level Haar wavelet decomposition in order to generate approximation coefficients as raw features. Then, the features are normalized. Furthermore, lower dimensional data are obtained through KECA as samples. For the sakes of convenience and simplicity in visualization and comparison, the 5 dimensional raw features are reduced to 2 dimensional features.

100 output sample data for each fault class are collected in simulations. The first 50 sample data are used to train LSSVM in order to set up a classification model, and the rest 50 sample data are applied to test the performance of the model. The simulation procedure is shown in Fig. 1.

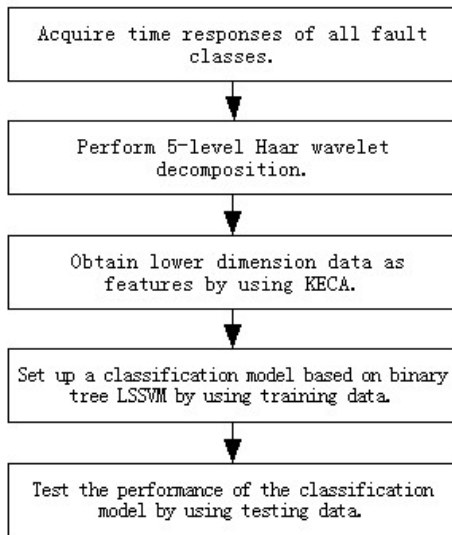

Fig. 1 Simulation procedure

3.2 Example 1—Sallen–Key Bandpass Filter

The circuit is shown in Fig. 2. Each component value has been labeled in the figure. R2, R3, C1 and C2 are selected as experiment components. The faulty impulse responses are measured in order to form 9 fault classes including R2↑, R2↓, R3↑, R3↓, C1↑, C1↓, C2↑, C2↓ and no fault (NF), where ↑ and ↓ refer to higher and lower than the nominal value, respectively. Fault codes, fault classes, the nominal and faulty component values are shown in Table 1.

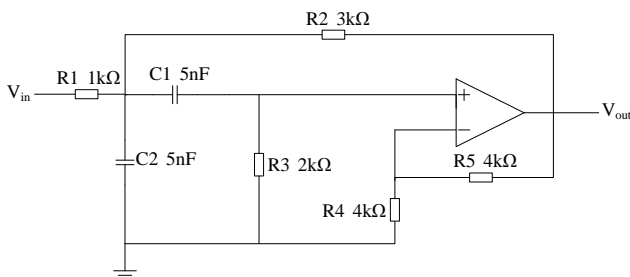

Fig. 2 Sallen–Key bandpass filter circuit

Table 1 Fault codes, fault classes, the nominal and faulty component values for bandpass filter

Fault code	Fault class	Nominal	Faulty value
F0	NF	-	-
F1	R2↑	3kΩ	3.75kΩ
F2	R2↓	3kΩ	2.25kΩ

F3	R3↑	2kΩ	2.5kΩ
F4	R3↓	2kΩ	1.5kΩ
F5	C1↑	5nF	6.25nF
F6	C1↓	5nF	3.75nF
F7	C2↑	5nF	6.25nF
F8	C2↓	5nF	3.75nF

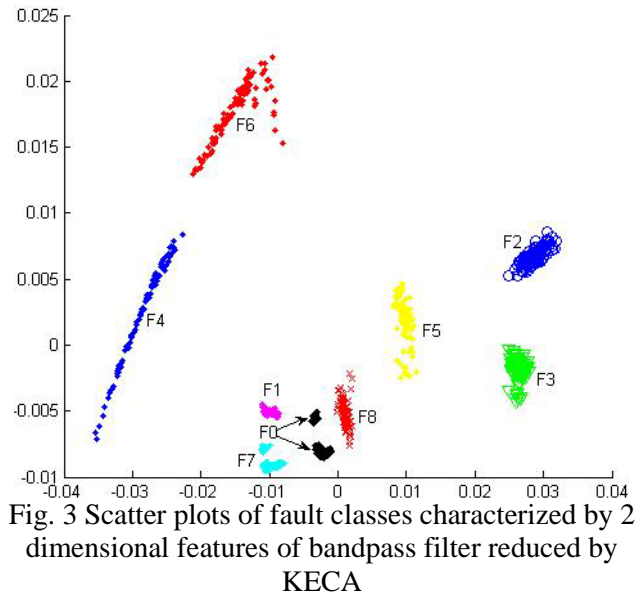

Fig. 3 Scatter plots of fault classes characterized by 2 dimensional features of bandpass filter reduced by KECA

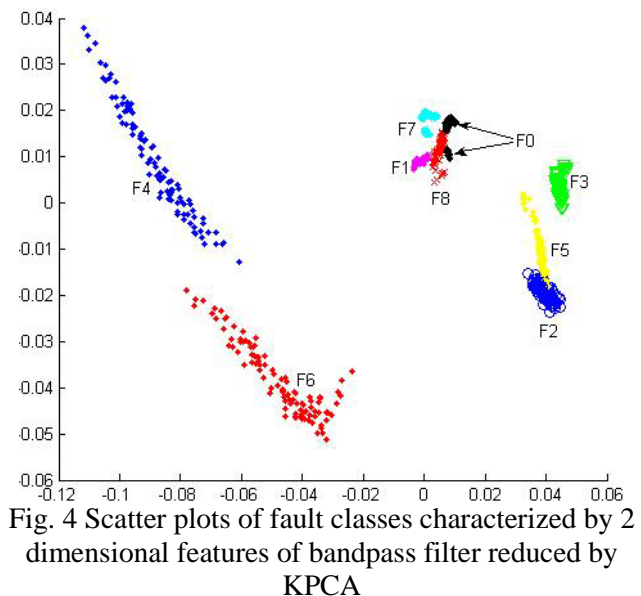

Fig. 4 Scatter plots of fault classes characterized by 2 dimensional features of bandpass filter reduced by KPCA

Subsequently, the 5 dimensional raw features of all fault classes are reduced to 2 dimensional features which contribute more to the Renyi entropy by using KECA. Fig. 3 reveals the scatter plots of fault classes characterized by the 2 dimensional features reduced by KECA. It is obviously that all fault classes are distinct ambiguity groups. This manifests different fault classes are well separated by using KECA.

In order to make a comparison, KPCA is applied to reduce the dimension of the raw features. The

reduced 2 dimensional features with the first 2 large eigenvalues are generated and shown in Fig. 4. The figure is similar to Fig. 3 because the two approaches are using the same data to generate lower dimensional features. It is obviously that F1, F2, F3, F4, F5, F6 and F7 fault classes are also distinct ambiguity groups in the figure. However, there is overlapping for F0 fault class and F8 fault class. This reveals that KECA can generate better extraction performance than KPCA.

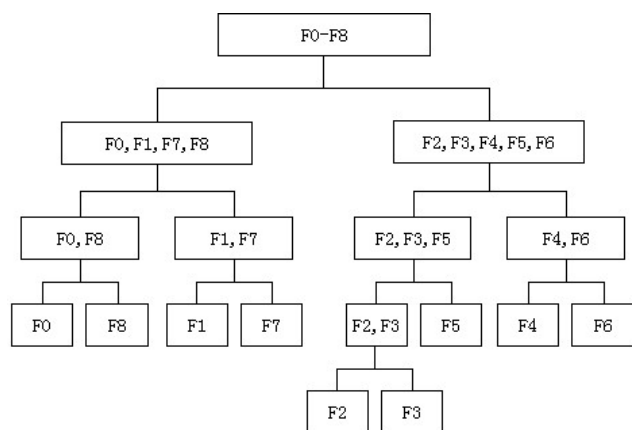

Fig. 5 Binary tree structure for bandpass filter

The constructed binary tree is shown in Fig. 5. All fault classes are classed into two fault class groups at the root of the tree by the first binary LSSVM. Afterward, the two fault class groups are classed into smaller groups by each binary LSSVM at the node of the tree in this fashion. This is repeated recursively downward the tree until reaches a leaf node that represents the class it has been assigned to. 8 LSSVM classifiers are used in total. The overall diagnosis accuracy is 100%.

3.3 Example 2—Leapfrog Filter

Leapfrog filter is shown in Fig. 6, and it is a benchmark circuit of ITC97. The circuit is more

complex for the reason of it is consisted of 4 capacitors, 13 resistors and 6 operational amplifiers. Each component value has been labeled in the figure. R1, R2, R4, R5, R6, R7, R9, R12, R13, C1 and C2 are selected as experiment components. 23 fault classes including R1↑, R1↓, R2↑, R2↓, R4↑, R4↓, R5↑, R5↓, R6↑, R6↓, R7↑, R7↓, R9↑, R9↓, R12↑, R12↓, R13↑, R13↓, C1↑, C1↓, C2↑, C2↓ and no fault (NF) are formed. Fault codes, fault classes, the nominal and faulty component values are shown in Table 2.

Table 2 Fault codes, fault classes, the nominal and faulty component values for leapfrog filter

Fault code	Fault class	Nominal	Faulty value
F0	NF	-	-
F1	R1↑	10kΩ	12.5kΩ
F2	R1↓	10kΩ	7.5kΩ
F3	R2↑	10kΩ	12.5kΩ
F4	R2↓	10kΩ	7.5kΩ
F5	R4↑	10kΩ	12.5kΩ
F6	R4↓	10kΩ	7.5kΩ
F7	R5↑	10kΩ	12.5kΩ
F8	R5↓	10kΩ	7.5kΩ
F9	R6↑	10kΩ	12.5kΩ
F10	R6↓	10kΩ	7.5kΩ
F11	R7↑	10kΩ	12.5kΩ
F12	R7↓	10kΩ	7.5kΩ
F13	R9↑	10kΩ	12.5kΩ
F14	R9↓	10kΩ	7.5kΩ
F15	R12↑	10kΩ	12.5kΩ
F16	R12↓	10kΩ	7.5kΩ
F17	R13↑	10kΩ	12.5kΩ
F18	R13↓	10kΩ	7.5kΩ
F19	C1↑	10nF	12.5nF
F20	C1↓	10nF	7.5nF
F21	C2↑	20nF	25nF
F22	C2↓	20nF	15nF

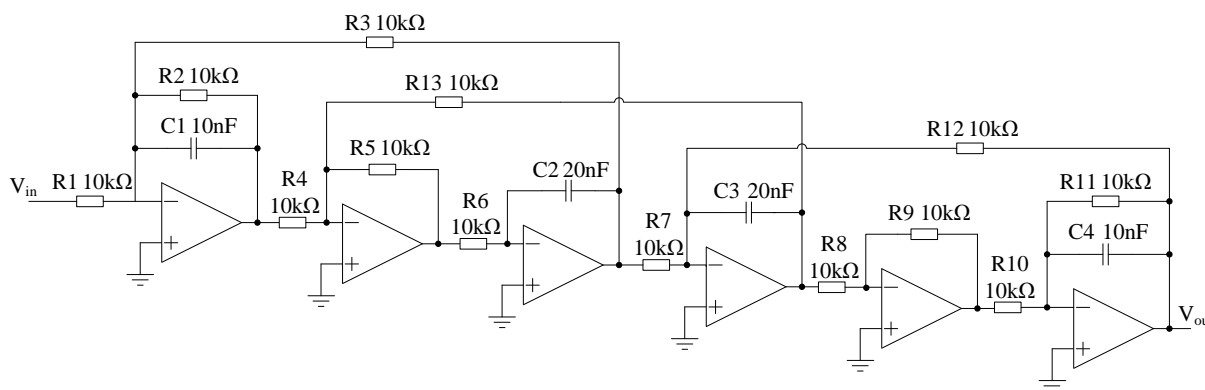

Fig. 6 Leapfrog filter circuit

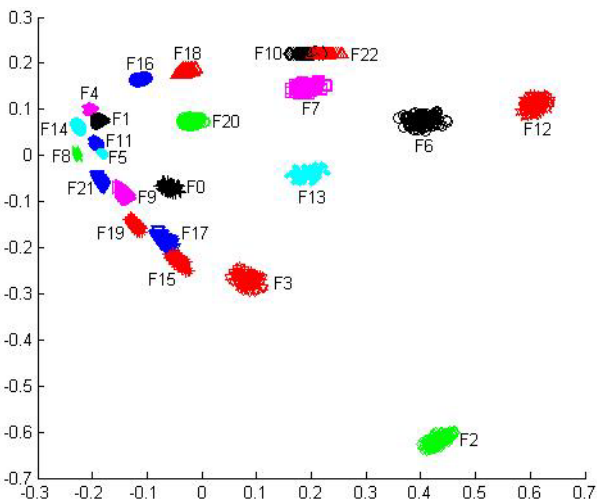

Fig. 7 Scatter plots of fault classes characterized by 2 dimensional features of leapfrog filter reduced by KECA.

After acquiring 5 dimensional raw features, KECA is utilized to reduce the dimension of features from 5 to 2. Fig. 7 reveals the scatter plots of fault classes characterized by 2 dimensional features. It is obviously that F0, F1, F2, F3, F4, F5, F6, F7, F8, F9, F11, F12, F13, F14, F15, F16, F17, F18, F19, F20 and F21 fault classes are distinct ambiguity groups. However, there is partially overlapping for F10 fault class and F22 fault class. Fig. 8 shows the scatter plots of fault classes characterized by 2 dimensional features reduced by using KPCA. F0, F1, F2, F3, F4, F5, F6, F7, F8, F9, F11, F12, F13, F14, F16, F18, F19, F20 and F21 fault classes are distinct ambiguity groups in the figure. Nevertheless, there is seriously overlapping for F10 fault class and F22 fault class, and slightly overlapping for F15 fault class and F17 fault class. This example also reveals that KECA can generate better extraction performance than KPCA.

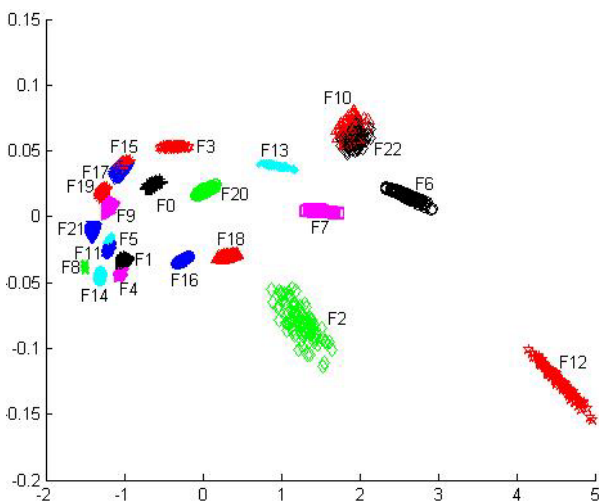

Fig. 8 Scatter plots of fault classes characterized by 2 dimensional features of leapfrog filter reduced by KPCA

Table 3 Accuracies of the diagnosis approach for leapfrog filter

Fault code	Fault class	Accuracy
F0	NF	100%
F1	R ₁ ↑	100%
F2	R ₁ ↓	100%
F3	R ₂ ↑	100%
F4	R ₂ ↓	100%
F5	R ₄ ↑	100%
F6	R ₄ ↓	100%
F7	R ₅ ↑	100%
F8	R ₅ ↓	100%
F9	R ₆ ↑	100%
F10	R ₆ ↓	94%
F11	R ₇ ↑	100%
F12	R ₇ ↓	100%
F13	R ₉ ↑	100%
F14	R ₉ ↓	100%
F15	R ₁₂ ↑	100%
F16	R ₁₂ ↓	100%
F17	R ₁₃ ↑	100%
F18	R ₁₃ ↓	100%
F19	C ₁ ↑	100%
F20	C ₁ ↓	100%
F21	C ₂ ↑	100%
F22	C ₂ ↓	92%

The constructed binary tree is shown in Fig. 9 and 22 LSSVM classifiers are used. Table 3 demonstrates the accuracies of the diagnosis approach in identifying the 23 fault classes. The F0, F1, F2, F3, F4, F5, F6, F7, F8, F9, F11, F12, F13, F14, F15, F16, F17, F18, F19, F20 and F21 fault classes can be classified correctly. Meanwhile, 50 test data of F10 fault class are classified correctly 47 times and misclassified as F22 fault class 3 times; 50 test data of F22 fault class are classified correctly 46 times and misclassified as F10 fault class 4 times. The overall diagnosis accuracy is 99.4%.

As can be seen from Figs. 3, 4, 7 and 8, the separability of features reduced by using KECA is further enlarged than by using KPCA, which represents different fault classes can be better separated by using KECA. Therefore, applying KECA which chooses components based on Renyi entropy to reduce high dimension of features in analog circuit incipient fault diagnosis is more appropriate than using KPCA which is choosing components based on top eigenvalues.

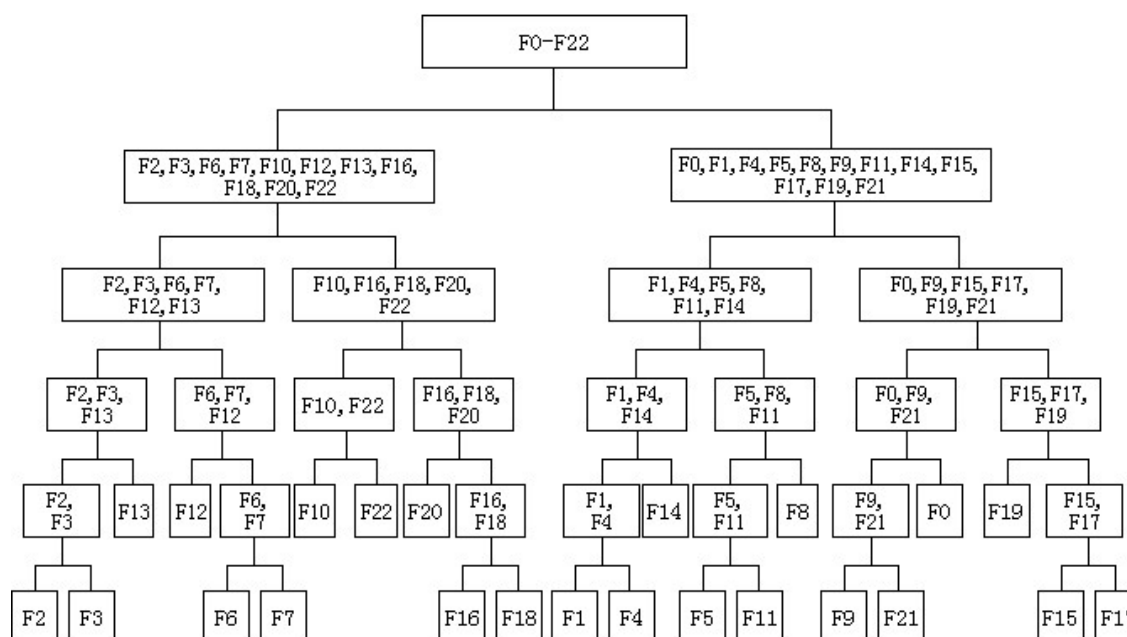

Fig. 9 Binary tree structure for leapfrog filter

Table 4 Diagnosis accuracies of our approach and the referenced approaches

Example	Reference [6]	Reference [7]	Reference [9]	Our work
bandpass filter	96.9%	99.1%	99.6%	100%
leapfrog filter	95.7%	98.2%	99.1%	99.4%

3.4 Comparison simulation

For the purpose of validating the effectiveness of KECA presented in the work, the approach is compared with PCA [6], KPCA [7] and KLDA [9] which are commonly used in analog circuit fault diagnosis as data transformation and dimension reduction approaches. 5 dimensional raw features of example 1 and example 2 are used, and the incipient fault diagnosis simulation steps and conditions are the same with our work. The diagnosis accuracy of each approach is shown in Table 4. From the results of the table, it can be seen that performing incipient fault by using KECA as a preprocessor can obtain more positive results than by using PCA, KPCA and KLDA, which represents that KECA can generate better extraction performance than PCA, KPCA and KLDA in dimension reduction.

4 Conclusions

In this work, a novel approach has been presented to perform analog circuit incipient fault diagnosis by using KECA as a preprocessor. Wavelet transform on time responses has produced raw features which are related to each of fault classes. KECA has been used to reduce the dimension of raw features from 5 dimensional to 2 dimensional. Different fault classes

have been identified by binary tree LSSVM. Through comparing the scatter plots of fault classes characterized by 2 dimensional features reduced by using KECA and KPCA respectively, it can be easily concluded that KECA can generate better separability of features than KPCA. Comparison simulation results have also verified that the proposed approach can produce higher diagnosis accuracy than the commonly used methods.

Acknowledgements

This work was supported by National Natural Science Foundation of China No. 51577046, the National Defense Advanced Research Project Grant No.C1120110004, 9140A27020211DZ5102, the Key Grant Project of Chinese Ministry of Education under Grant No.313018, Anhui Provincial Science and Technology Foundation of China under Grant No. 1301022036, Anhui Provincial Natural Science Foundation No.1608085QF157 and Key projects of Anhui province university outstanding youth talent support program No. gxyqZD2016207.

References:

- [1] A. Pułka, Two heuristic algorithms for test point selection in analog circuit diagnoses, *Metrology and Measurement Systems*, Vol.18, No.1, 2011, pp. 115-128.
- [2] R. Spina, S. Upadhyaya, Linear circuit fault diagnosis using neuromorphic analyzers, *IEEE Transactions on Circuits and Systems II: Analog and Digital Signal Processing*, Vol.44, No.3, 1997, pp. 188-196.
- [3] F. Aminian, M. Aminian, Jr. H. W. Collins, Analog fault diagnosis of actual circuits using neural networks, *IEEE Transactions on Instrumentation and Measurement*, Vol.51, No.3, 2002, pp. 544-550.
- [4] M. Aminian, F. Aminian. A, modular fault-diagnostic system for analog electronic circuits using neural networks with wavelet transform as a pre-processor, *IEEE Transactions on Instrumentation and Measurement*, Vol.56, No.5, 2007, pp. 1546-1554.
- [5] F. Aminian, M. Aminian, Fault diagnosis of analog circuits using Bayesian neural networks with wavelet transform as pre-processor, *Journal of electronic testing*, Vol.17, No.1, 2001, pp. 29-36.
- [6] Y. Xiao, Y. He, A linear ridgelet network approach for fault diagnosis of analog circuit, *Science China Information Sciences*, Vol.53, No.11, 2010, pp. 2251-2264.
- [7] Y. Xiao, L. Feng, A novel linear ridgelet network approach for analog fault diagnosis using wavelet-based fractal analysis and kernel PCA as preprocessors, *Measurement*, Vol.45, No.3, 2012, pp. 297-310.
- [8] L. Xu, J. Huang, H. Wang, et al. A novel method for the diagnosis of the incipient faults in analog circuits based on LDA and HMM, *Circuits, Systems and Signal Processing*, Vol.29, No.4, 2010, pp. 577-600.
- [9] Y. Xiao, L. Feng, A novel neural-network approach of analog fault diagnosis based on kernel discriminant analysis and particle swarm optimization, *Applied Soft Computing*, Vol.12, No.2, 2012, pp. 904-920.
- [10] L. Yuan, Y. He, J. Huang, et al. A new neural-network-based fault diagnosis approach for analog circuits by using kurtosis and entropy as a pre-processor, *IEEE Transactions on Instrumentation and Measurement*, Vol.59, No.3, 2010, pp. 586-595.
- [11] Y. He, Y. Tan, Y. Sun, Wavelet neural network approach for fault diagnosis of analogue circuits, *IEE Proceedings-Circuits, Devices and Systems*, Vol.151, No.4, 2004, pp. 379-384.
- [12] Y. Tan, Y. He, C. Cui, et al. A novel method for analog fault diagnosis based on neural networks and genetic algorithms, *IEEE Transactions on Instrumentation and Measurement*, Vol.57, No.11, 2008, pp. 2631-2639.
- [13] D. Grzechca, J. Rutkowski, Fault diagnosis in analog electronic circuits-the SVM approach, *Metrology and Measurement Systems*, Vol.16, No.4, 2009, pp. 583-598.
- [14] J. Cui, Y. Wang, A novel approach of analog circuit fault diagnosis using support vector machines classifier, *Measurement*, Vol.44, No.1, 2011, pp. 281-289.
- [15] A. S. S. Vasan, B. Long, Pecht M. Diagnostics and prognostics method for analog electronic circuits, *IEEE Transactions on Industrial Electronics*, Vol.60, No.11, 2013, pp. 5277-5291.
- [16] B. Long, S. Tian, H. Wang, Diagnostics of filtered analog circuits with tolerance based on LS-SVM using frequency features, *Journal of Electronic Testing*, Vol.28, No.3, 2012, pp. 291-300.
- [17] B. Long, S. Tian, H. Wang, Feature vector selection method using Mahalanobis distance for diagnostics of analog circuits based on LS-SVM, *Journal of Electronic Testing*, Vol.28, No.5, 2012, pp. 745-755.
- [18] C. Cortes, V. Vapnik, Support-vector networks, *Machine learning*, Vol.20, No.3, 1995, pp. 273-297.
- [19] J. A. K. Suykens, J. Vandewalle, Least squares support vector machine classifiers, *Neural processing letters*, Vol.9, No.3, 1999, pp. 293-300.
- [20] R. Jenssen, Kernel entropy component analysis, *IEEE Transactions on Pattern Analysis and Machine Intelligence*, Vol.32, No.5, 2010, pp. 847-860.