

Performance Analysis of a Multi-Source, Single-Output, Buck-Boost DC-AC Converter Feeding Active Power to a 3-Phase Distribution Grid

M EZZAT

Department (Electrical Engineering)

University (Menofia University)

Address (Shebin El_Kom)

COUNTRY (EGYPT)

en.ezzat@yahoo.com

Abstract: - No doubt that, power electronics play an important role in the modern industry and power system networks. This paper presents the performance analysis of a multi-source, single-output, buck-boost dc-ac converter suitable for use in different applications such as feeding ac loads from photovoltaic systems. In this paper, the performance of the proposed converter is studied, through power simulation program (PSIM), under different modes of operation during feeding active power to a distribution network. The most important features of the proposed converter are the possibility to control voltage, frequency, voltage and frequency together, and the low value of the total harmonic distortion (THD) in the voltage and current waveforms.

Key-Words: - Buck-Boost, DC- AC Converter, Design, Performance, Simulation

1 Introduction

Now days, power electronics are extensively used in electrical power applications. It can be found in a lot of applications such as feeding dc loads from ac supplies, feeding ac loads from dc supplies (e.g. batteries and photovoltaic cells), voltage regulation of electrical sources, electrical drives, FACTS devices and a lot of applications. Frankly speaking, they become indispensable parts of the industrial and power life. DC-AC converter [2-7] is a one of power electronic converters which used in different applications such as feeding ac loads from photovoltaic cells. According to the number of sources, they can be classified to single-source converter, double-source converter and multiple-source converter. Single-source dc-ac buck-boost converters are extensively presented in a lot of papers. Recently, the double-source dc-ac buck-boost converter has been presented by M EZZAT [1]. In this research, the study of a multiple-source dc-ac buck-boost converter is presented. This converter uses the same principle of control of the double-source converter presented in [1]. Also, the performance of the proposed converter is studied when feeding power to a distribution network under different operating conditions such as voltage variation of one or more than one of the feeding sources.

2 Construction of the Multiple-Source Converter

Fig. 1 shows the circuit diagram of only one phase of the proposed converter. As shown from the figure, the proposed converter consists of two simple choppers feeding a half bridge inverter. The chopper switches are controlled so as to make the capacitor voltage vary in a half-wave sinusoidal manner (The control technique will be described in the next sections). As seen from the figure, the converter contains four switches. Fig. 2 shows the block diagram of the proposed multi-source converter. As seen from this figure, the converter consists of three similar single-phase converters each supplied from two separate dc source (the excitation source may be a photovoltaic cell).

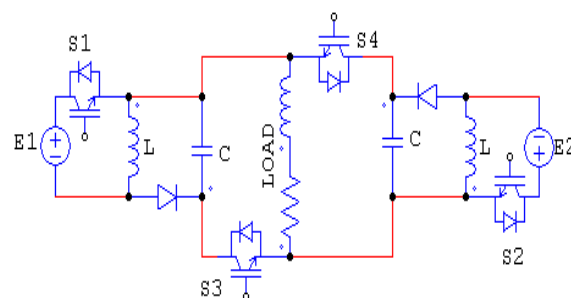

Circuit Diagram of a One-Phase of the Proposed Multi-Source, DC-AC Buck-Boost Converter
Fig. 1

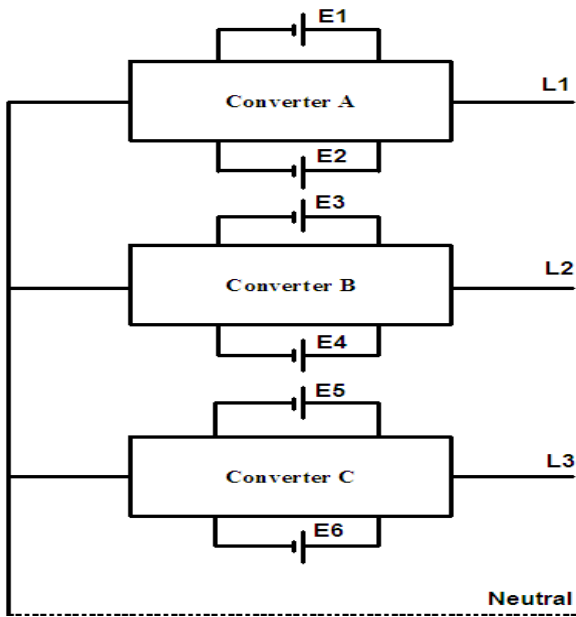

Block Diagram of the Proposed Multi-Source, DC-AC Buck-Boost Converter
Fig. 2

3 Principle of Operation

The principle of operation of the proposed converter can be discussed as follows:

The DC-DC choppers provide DC output voltages lower or higher than the supplies voltage. The principle of operation of each chopper circuit can be discussed as follows:

Figs. 3a & 3b show the modes of operation of the DC-DC chopper. From these figures, the principle of operation of this converter can be discussed as follows:

- When the switch S1 is turned on, the current rises through the inductor and the inductor voltage polarity will be in a direction that opposes the supply polarity.
- When the switch S1 is opened, the inductor reverses its polarity and a current passes through the diode to charge the capacitor C. The capacitor voltage depends on the duty ratio at which the semiconductor switch is switched.

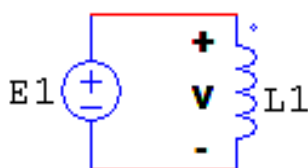

Equivalent Circuit for S1 is Closed
Fig. 3a

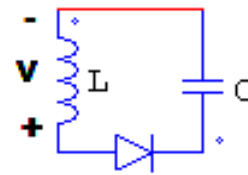

Equivalent Circuit for S1 is Opened
Fig. 3b

The function of the DC-AC converter (Half Bridge Inverter) is to convert the output voltage from the DC-DC converter to AC voltage. Figs. 4a & 4b show the modes of operation of this converter.

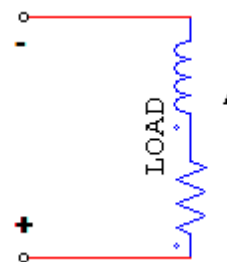

Equivalent Circuit for S3 is Closed & S4 is Opened
Fig. 4a

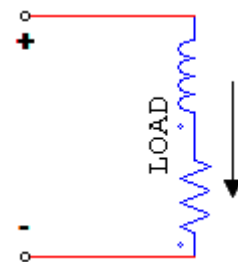

Equivalent Circuit for S3 is Opened & S4 is Closed
Fig. 4b

4 Principle of Converter Control

To reduce the total harmonic distortion in the current and voltage waveforms, the output voltage from the proposed converter is controlled to track a reference sinusoidal signal. The positive half-wave of the reference signal acts as a reference to the left hand side converter and the negative half-wave acts as a reference to the right hand side converter. In this paper, the reference signal is a sinusoidal signal with its phase angle is generated from the error signal resulting from comparing the reference power by the measured power. In this paper, a simple proportional-integral (PI) controller is used but any controller types can be used. Figs. 5a & 5b illustrating the philosophy of reference phase angle generation for the three phases. Fig. 5c shows the schematic diagram of the proposed control for only

one-phase. The control for the other two phases is similar to the control of phase A. for this block, a simple proportional-differential (PD) controller is chosen.

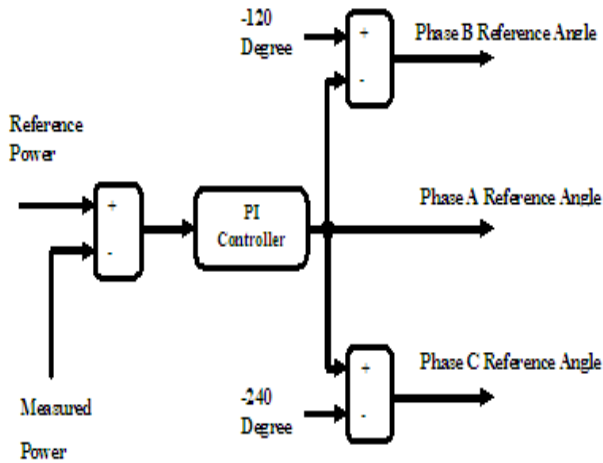

Reference Phase Angle Generation
Fig. 5a

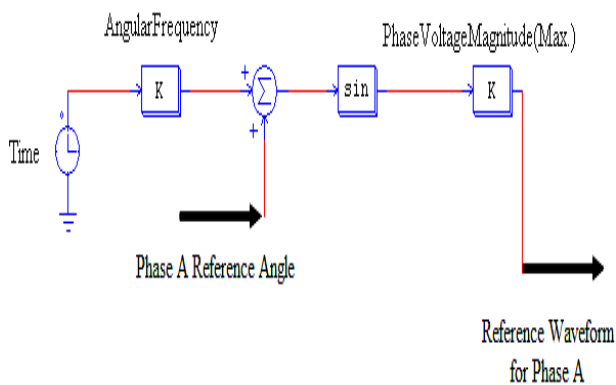

Reference Sinusoidal Signal Generation
Fig. 5b

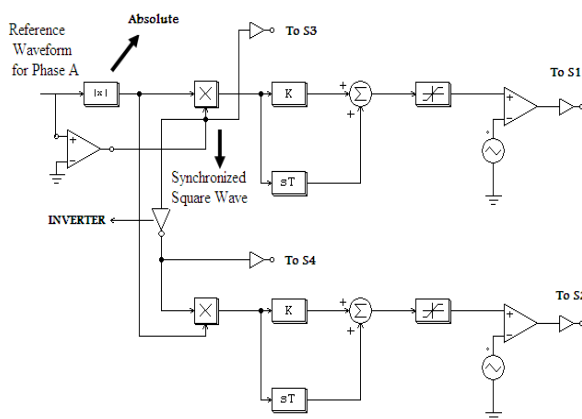

Schematic Diagram of the IGBT_s Controller
Fig. 5c

5 Simulation of the Proposed Converter When Feeding a 3-Phase Distribution System

This section presents the performance of the proposed converter under closed loop control when feeding active power to a 3-phase distribution grid. In this paper, the distribution grid is modeled as a 3-phase voltage source behind impedance as depicted by Thevenin theorem and the control strategy is done as described before in section 4. Fig. 6 shows the schematic diagram of the proposed converter feeding a 3-phase grid as studied in this paper.

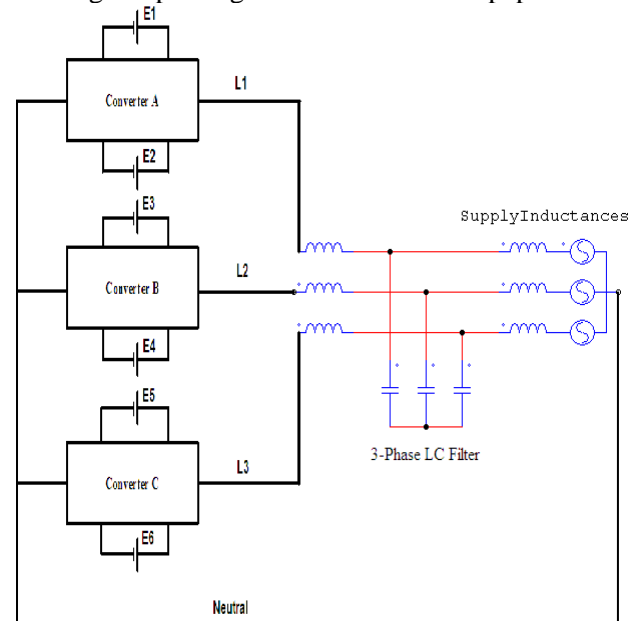

Schematic Diagram of the Proposed Converter Feeding a 3-Phase Grid
Fig. 6

Fig. 7a shows the reference and the measured power for a power command (reference) of 500 watt. From this figure, it can be seen that the measured power is equal to the reference power (approximately).

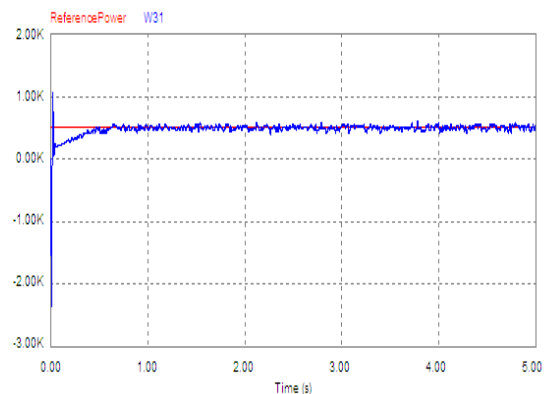

Reference and Measured Power
Fig. 7a

Fig. 7b&7c show the generated sinusoidal reference signal for phases A and the synchronized square wave respectively.

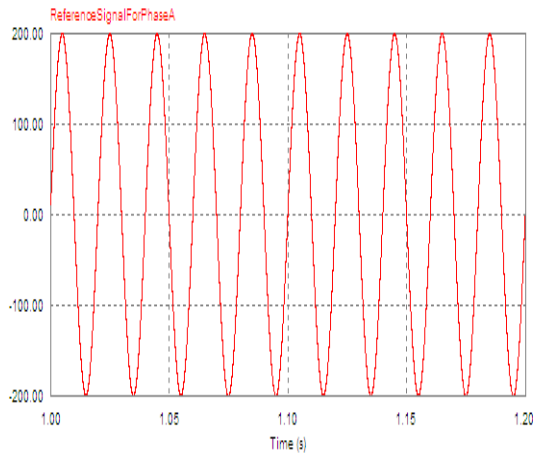

Reference Sinusoidal Signal for Phase A
Fig. 7b

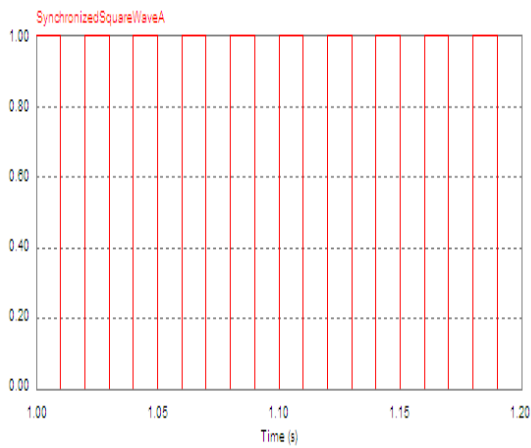

Synchronized Square Wave A
Fig. 7c

Fig. 7d&7e show the generated sinusoidal reference signal for phases B and the synchronized square wave respectively.

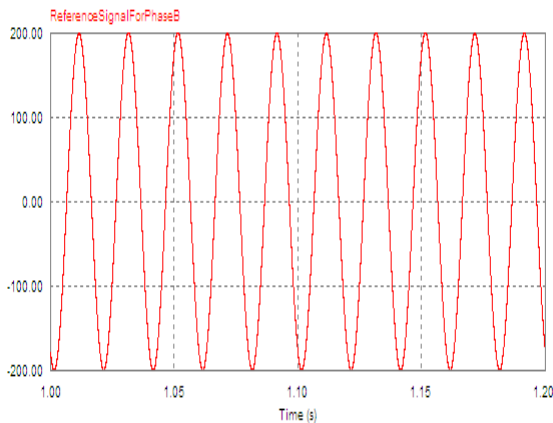

Reference Sinusoidal Signal for Phase B
Fig. 7d

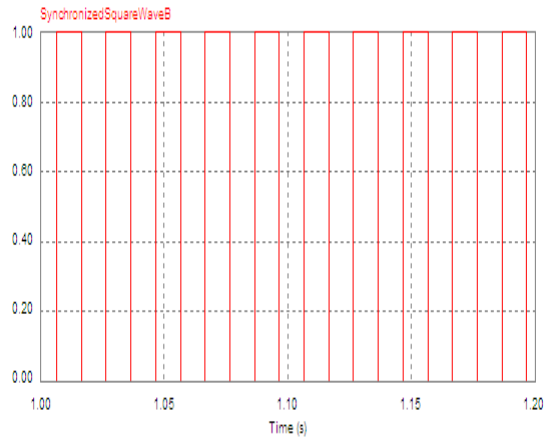

Synchronized Square Wave B
Fig. 7e

Fig. 8a&8b show the reference signals for the left hand side and the right hand side parts of phase A respectively.

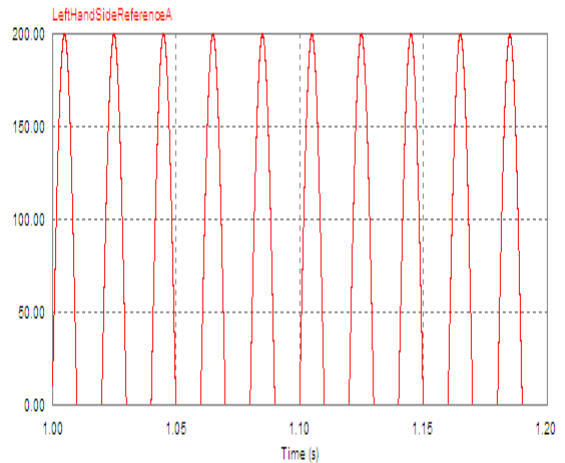

Reference Signal for the Left Hand Side of Phase A
Fig. 8a

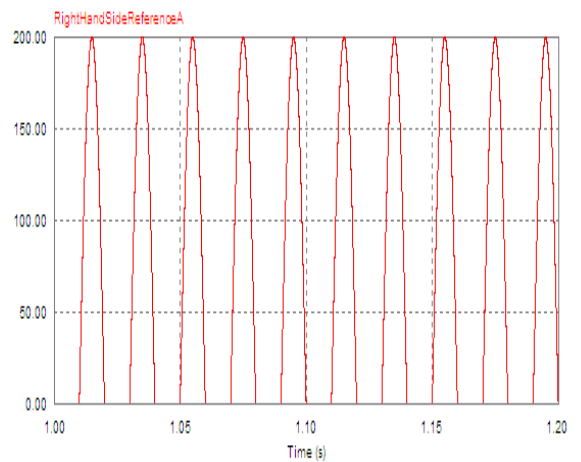

Reference Signal for the Right Hand Side of Phase A
Fig. 8b

Fig. 9a&9b show the 3-phase currents which injected to the distribution grid and the fast Fourier transform (FFT) of these currents respectively. From these figures, it can be seen that the injected current waveforms are very close to the sinusoidal waveforms which means low harmonic content.

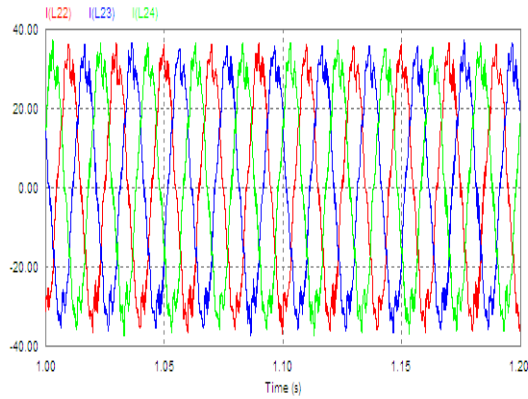

3-Phase Currents Injected to the Grid
Fig. 9a

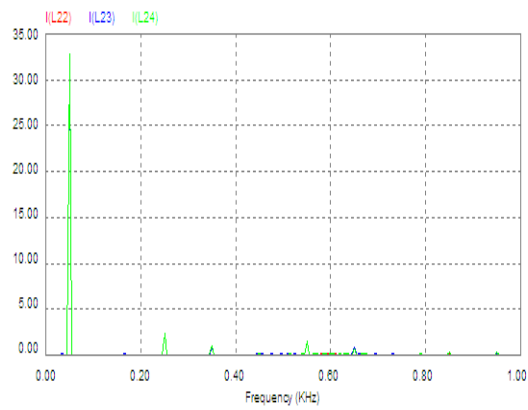

FFT of the 3-Phase Currents Injected to the Grid
Fig. 9b

Fig. 10a&10b show the 3-phase voltages across the converter terminals and the FFT of these voltages. Also, one can find that the harmonic content is very low.

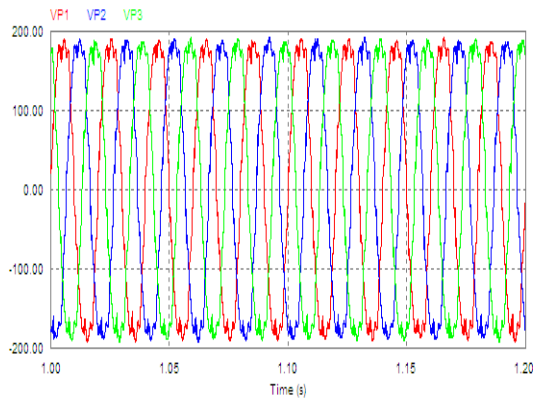

3-Phase Voltages across the Converter Terminals
Fig. 10a

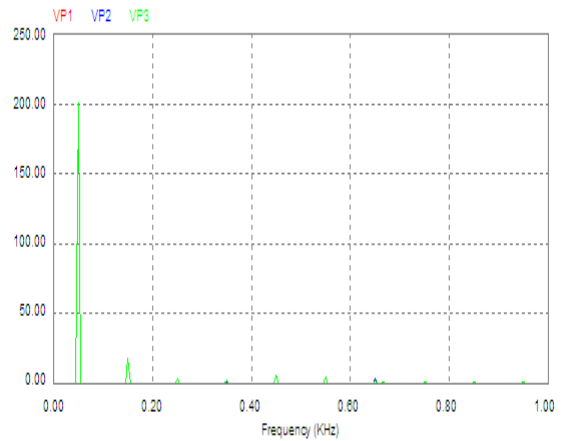

FFT of the 3-Phase Voltages across the Converter Terminals
Fig. 10b

Fig. 11a&11b show the left hand side supply current and the right hand side supply current that feeding converter A respectively.

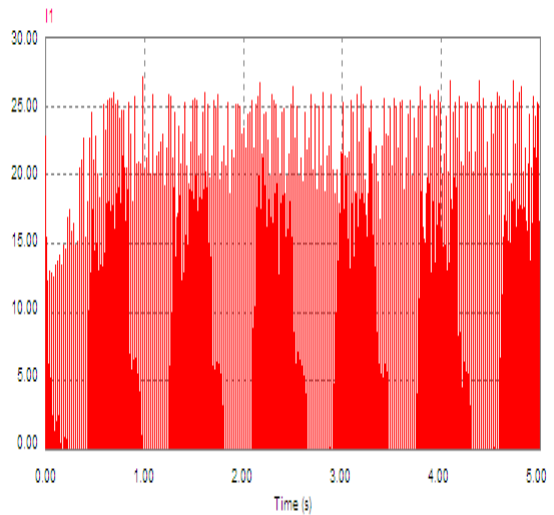

Left Hand Side Supply Current
Fig. 11a

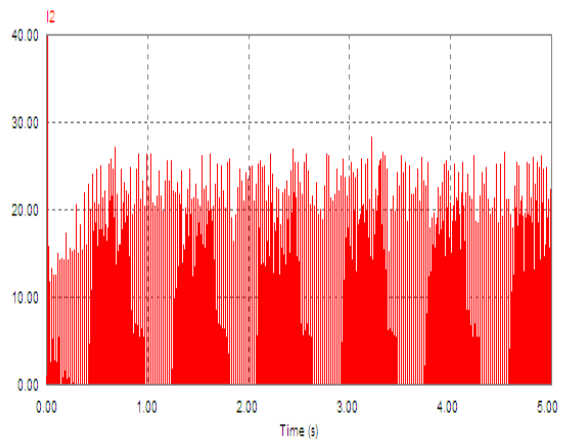

Right Hand Side Supply Current
Fig. 11b

Fig. 12a to 12d show the control pulses to the four switches (IGBT_s) included in phase A.

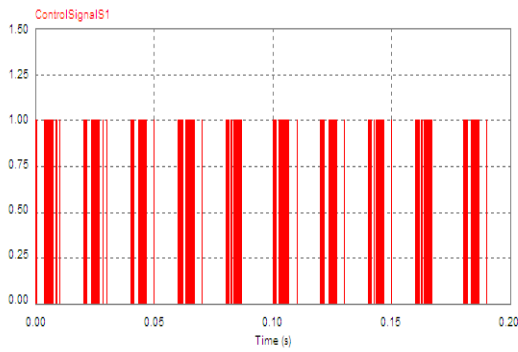

Control Signal to Switch S1
Fig. 12a

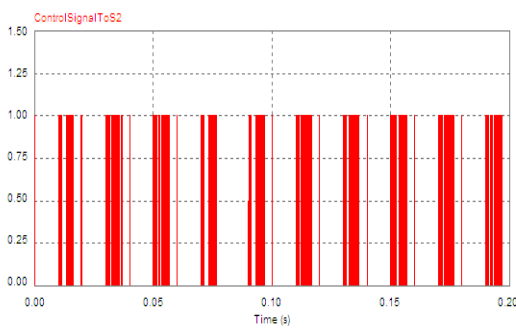

Control Signal to Switch S2
Fig. 12b

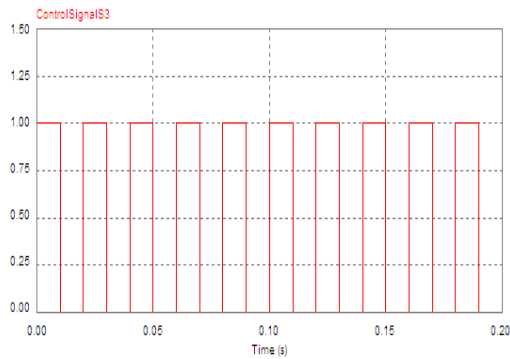

Control Signal to Switch S3
Fig. 12c

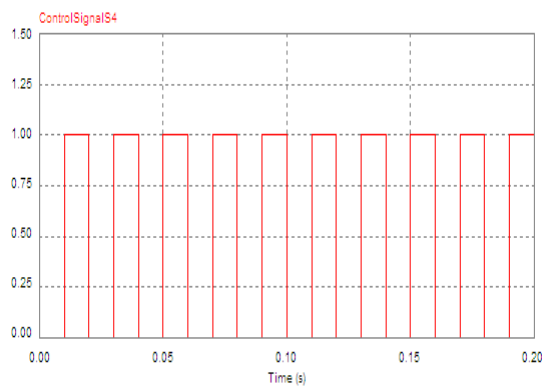

Control Signal to Switch S4
Fig. 12d

Fig. 13a shows the reference and the measured power for a power command (reference) of 1000 watt. From this figure, it can be seen that the measured power is equal to the reference power (approximately).

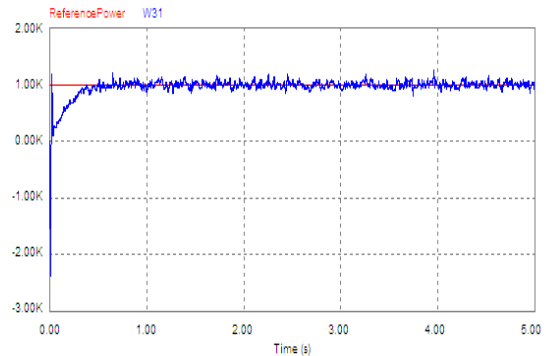

Reference and Measured Power
Fig. 13a

Fig. 13b&13cb show the 3-phase currents which injected to the distribution grid and the fast Fourier transform (FFT) of these currents respectively. From these figures, it can be seen that the injected current waveforms are very close to the sinusoidal waveform which means low harmonic content

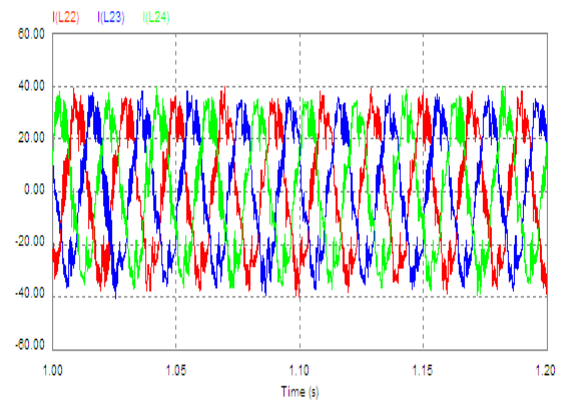

3-Phase Currents Injected to the Grid,
Power=1000 Watt
Fig. 13b

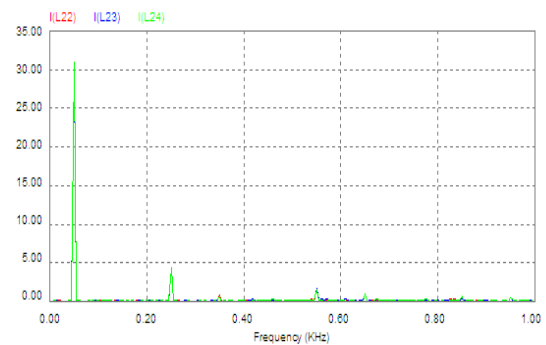

FFT of the 3-Phase Currents Injected to the Grid,
Power=1000Watt
Fig. 13c

Fig. 13d&13e show the 3 –phase voltages across the converter terminals and the FFT of these voltages. Also, one can find that the harmonic content is very low.

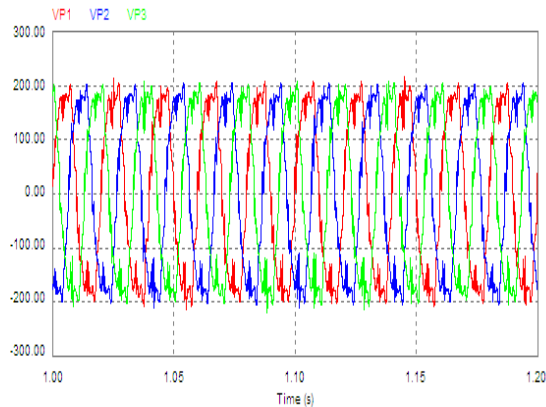

3-Phase Voltages across the Converter Terminals, Power=1000Watt Fig. 13d

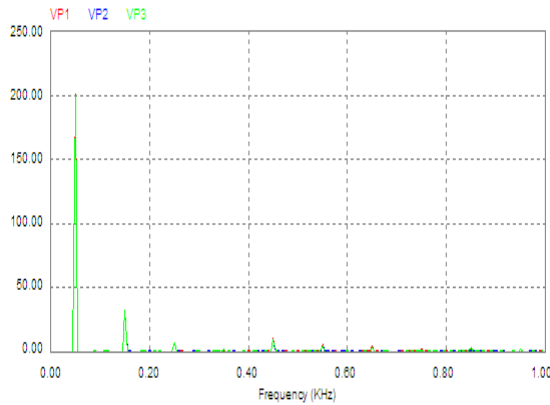

FFT of the 3-Phase Voltages across the Converter Terminals, Power=1000Watt Fig. 13e

Fig. 13f&13g show the left hand side supply current and the right hand side supply current that feeding converter A respectively.

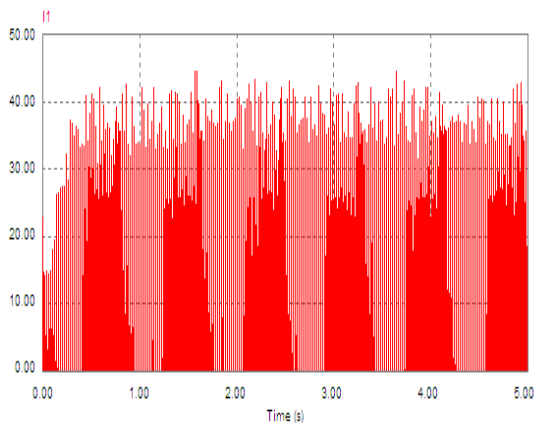

Left Hand Side Supply Current, Power=1000 Watt Fig. 13f

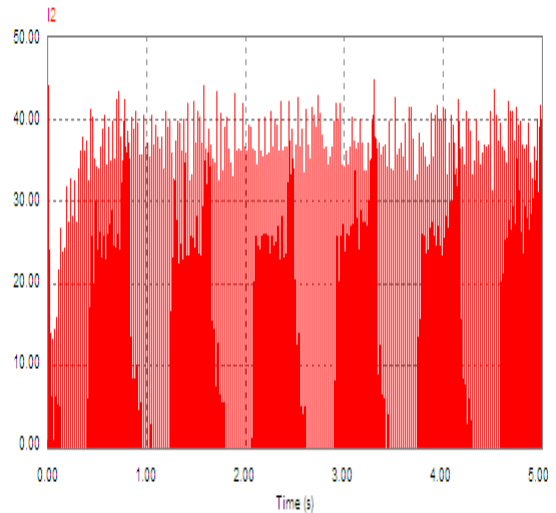

Right Hand Side Supply Current, Power=1000 Watt Fig. 13g

6 Simulation of the Proposed Converter under Supply Voltage Variations

This section presents the performance of the proposed converter under supply voltage variations. Fig. 14a shows the reference power and the measured power with a sudden change in one of the left hand side supplies from 100 volt to 80 volt.

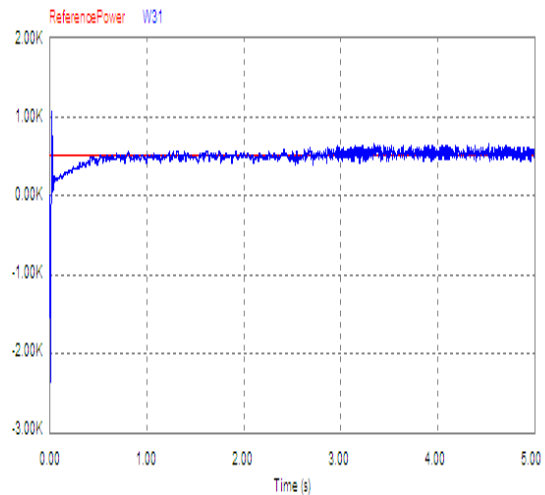

Reference and Measured Power, Sudden Change in One of the Left Hand Side Supplies Fig. 14a

Fig. 14b&14c show the 3-phase currents which injected to the distribution grid and the fast Fourier transform (FFT) of these currents respectively. Although there is a change in voltage in one of the left hand side supplies, the harmonic content in the injected currents remains low.

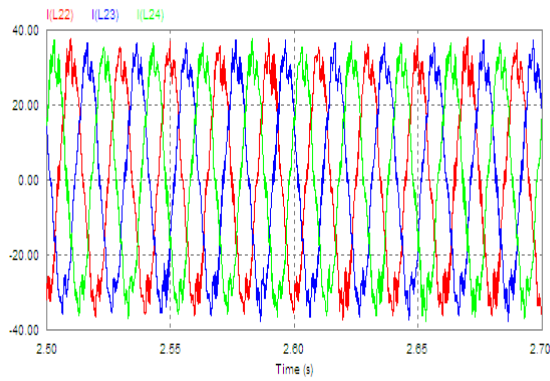

3-Phase Currents Injected to the Grid,
Sudden Change in One of the Left Hand Side
Supplies
Fig. 14b

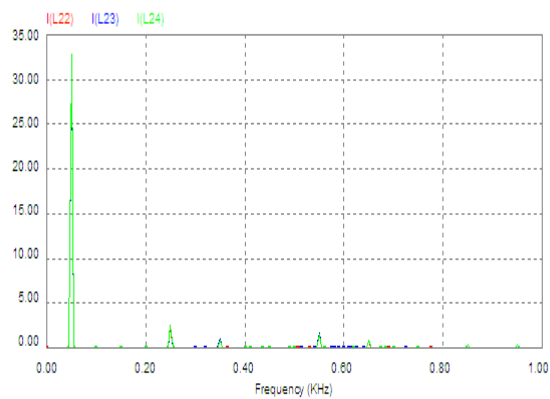

FFT of the 3-Phase Currents Injected to the Grid,
Sudden Change in One of the Left Hand Side
Supplies
Fig. 14c

Figs. 14d&14e show the 3-phase voltages across the converter terminals and the fast Fourier transform (FFT) of these voltages respectively. Although there is a change in voltage in one of the left hand side supplies, there is no effect appears on these voltages.

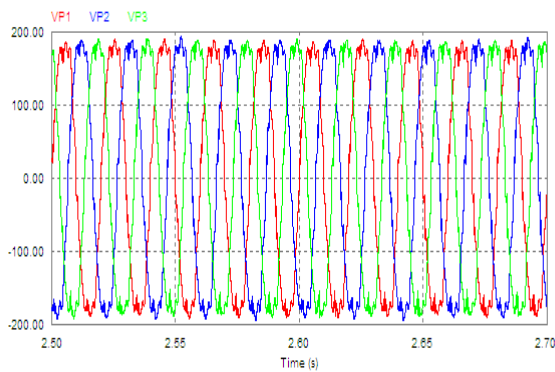

3-Phase Voltages across the Converter Terminals,
Sudden Change in One of the Left Hand Side
Supplies
Fig. 14d

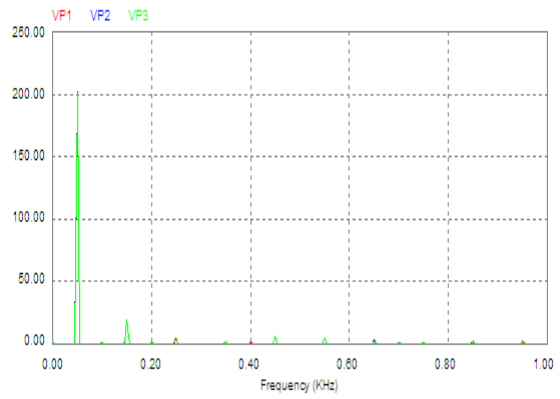

FFT of the 3-Phase Voltages across the Converter
Terminals, Sudden Change in One of the Left Hand
Side Supplies
Fig. 14e

Figs. 14f&14g show the left hand side supply current and the right hand side supply current that feeding converter A respectively.

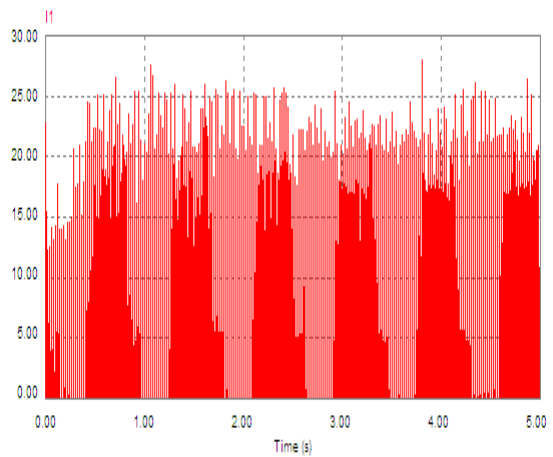

Left Hand Side Supply Current, Sudden Change in
One of the Left Hand Side Supplies
Fig. 14f

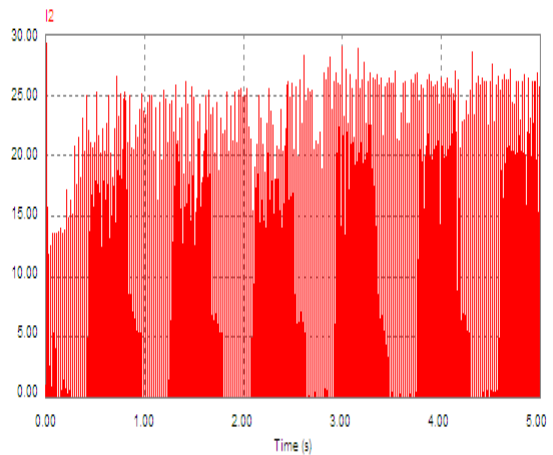

Right Hand Side Supply Current, Sudden Change in
One of the Left Hand Side Supplies
Fig. 14g

Fig. 15a shows the reference power and the measured power with a sudden change in all left hand side supplies from 100 volt to 80 volt.

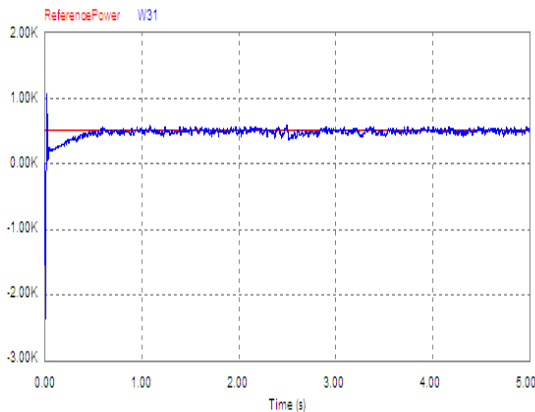

Reference and Measured Power, Sudden Change in All Left Hand Side Supplies
Fig. 15a

Figs. 15b&15c show the 3-phase currents which injected to the distribution grid and the fast Fourier transform (FFT) of these currents respectively during the sudden voltage change in all left hand side supplies.

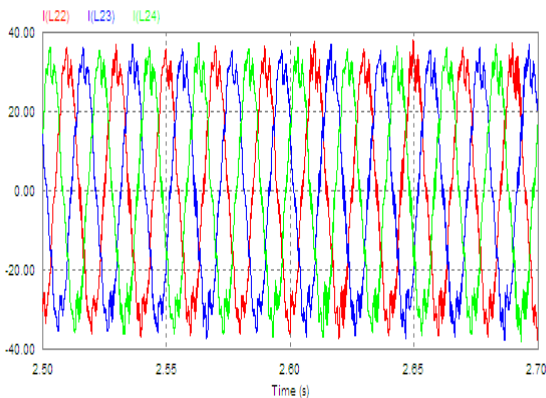

3-Phase Currents Injected to the Grid, Sudden Change in All Left Hand Side Supplies
Fig. 15b

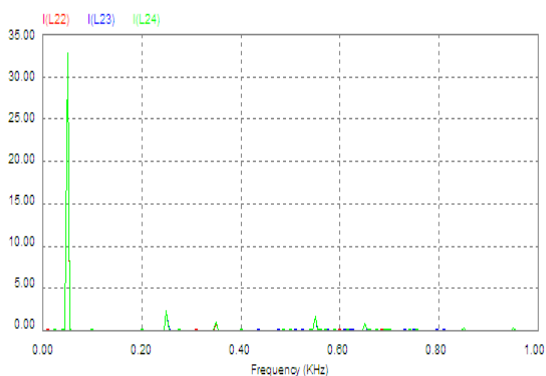

FFT of the 3-Phase Currents Injected to the Grid, Sudden Change in All Left Hand Side Supplies
Fig. 15c

Figs. 15d&15e show the 3-phase voltages across the converter terminals and the fast Fourier transform (FFT) of these voltages respectively during the sudden voltage change in all left hand side supplies.

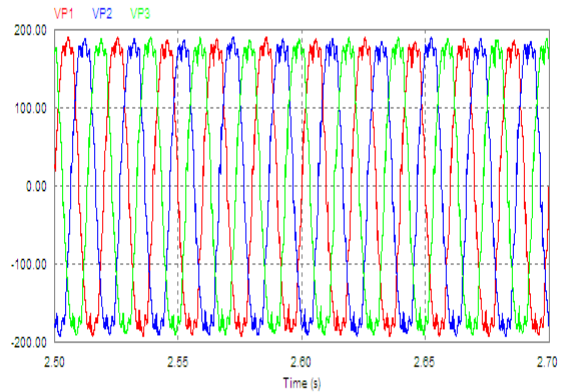

3-Phase Voltages across the Converter Terminals, Sudden Change in All Left Hand Side Supplies
Fig. 15d

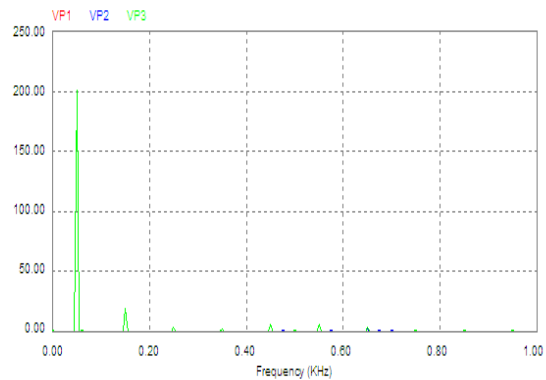

FFT of the 3-Phase Voltages across the Converter Terminals, Sudden Change in All Left Hand Side Supplies
Fig. 15e

Figs. 15f&15g show the left hand side supply current and the right hand side supply current that feeding converter A respectively during the sudden voltage change in all left hand side supplies.

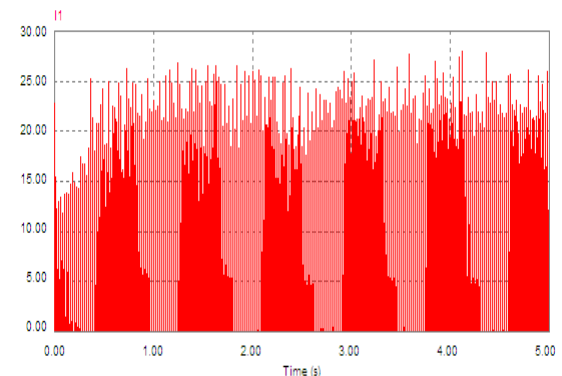

Left Hand Side Supply Current, Sudden Change in All Left Hand Side Supplies
Fig. 15f

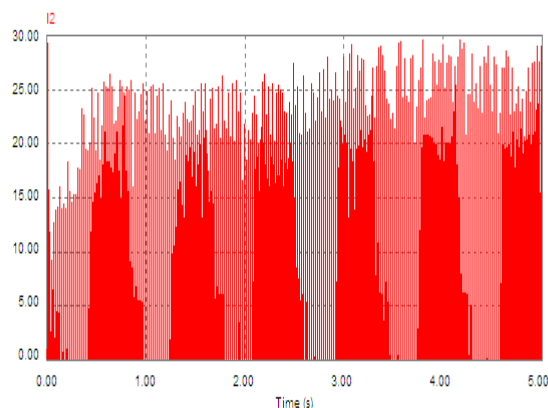

Right Hand Side Supply Current, Sudden Change in All Left Hand Side Supplies
Fig. 15f

From all the above results, it can be shown that the performance of the proposed converter seems to be good under normal and abnormal conditions.

7 Conclusion

The performance analysis of a multi-source, buck-boost dc-ac converter has been presented. Also, the simulation of this converter has been presented, through PSIM, in different modes of operation. The performance of the proposed converter has been found to be good especially, with the variable voltage sources so that it can be used with the photovoltaic applications.

References:

- [1] M. Ezzat , *A Doubly Excited DC-to-3-Phase AC Buck-Boost Converter Gives Sinusoidal Waveforms: Design, Simulation & Control*, Wseas Transactions on Circuits and Systems, Vol. 10, No. 4, April 2011, PP. 126-135.
- [2] Rafia Akhter, *A New Technique of PWM Boost Inverter for Solar Home Applications*, BRAC University Journal, Vol. 4, No. 1, Oct. 2007, PP. 39-45.
- [3] Pablo Sanchis et al, *Boost DC-AC Inverter: A New Control Strategy*, IEEE Transactions on Power Electronics, Vol. 20, No. 2, March 2005, PP. 343-353.
- [4] Liuchen Chang et al, *A Novel Buck-Boost Inverter for Photovoltaic Systems*, Canadian Solar Buildings Conference, Montreal, 20-24 Aug. 2004, PP. 1-8.
- [5] Fang Zheng Peng, *Z-Source Inverter* , IEEE Transactions on Industry Applications, Vol. 39, No. 2, 2003, PP. 504-510.

- [6] Hans Ertl et al, *A Novel Multicell DC-AC Converter for Applications in Renewable Energy Systems*, IEEE Transactions on Industrial Electronics, Vol. 49, No. 5, Oct. 2002, PP. 1048-1057.
- [7] Ramon O. Cáceres, Ivo Barbi, *A Boost DC-AC Converter: Analysis, Design, and Experimentation* , IEEE Transactions on Power Electronics, Vol. 14, No. 1, Jan. 1999, PP. 134-141.

Appendix:

Circuit Parameters:

- Converter Capacitance =50 micro Farad.
- Converter Inductance =1milli Henry.
- Resistance of the Inductor = 1 Ohm.
- P Controller Gain= 15. (For the PD Controller)
- Differentiator Time Constant = 0.004 Sec.
- Filter Inductance =1milli Henry.
- Filter Capacitance=500 micro Farad.
- P Controller Gain= 1e-4. (For the PI Controller)
- Integrator Time Constant = 0.001 Sec.
- Grid Inductance = 1e-5 Henry.