

On the improvement of the High Frequency traceability chain: application to attenuators

NADIA FEZAI, ABDESSATTAR BEN AMOR
 Department of Engineering Physics and Instrumentation
 University of Carthage Tunisia
nadiafezai@yahoo.fr , mrdssrst@yahoo.fr

Abstract: - The ISO/CEI 17025 standard requires to validate the testing and analytical methods when they are standardized or after amplification or modification of these methods. A measurement uncertainty must also be associated with the results.

In High Frequency, All measurement devices must be linked with a reference called standard. In high frequency attenuation, there is no physical standards in this area for most of the national metrology laboratories. Thus, a large number of theoretical measurement methods are adopted for the attenuators calibration.

This publication describes the feasibility of a computable method HF attenuation made by the laboratory of electrical metrology to ensure traceability to the SI (The international system of units). The method has been completely studied in order to determine its characteristic parameter: attenuation 'A'. All comparative results between classical method and adopted method are presented here.

Key-Words: - Variable attenuation, Intermediate Frequency (IF), Bolometric bridge, Power sensor, Power variation (PV), Reflection Factor.

1 Introduction

Metrology is the science of measurement, including all theoretical and practical aspects of measurement. Measured, it is compared, using a reference. Is to express the result of this comparison with a numerical value associated with a unit that reminds the nature of the reference, and with associated uncertainty that depends on the quality of the experiment performed and the knowledge that one has on the reference and conditions of use [1].

At present, the role of metrology is undeniable and its application areas in life are many. Indeed, the company relies on a vast infrastructure, and often invisible, services, foodstuffs, transportation and communication networks whose presence we are familiar and whose functioning is essential for daily life.

Metrology also occurs at different levels as the manufacture and trade of products, medical diagnosis, control of communication flows, and analysis of physical and chemical phenomena tracing systems, the definition and control of safety rules.

In the area of high frequency (HF), the wavelength is small compared to the physical dimensions of a transmission line length; current and voltage are not constant. This is the power that is measured. In all civil and military applications, we need to know the power input and output levels. The device used is the power meter. It does not measure the RF power

directly, but an intermediate amount, which itself is measurable. A sensitive element placed inside to absorb the power and turn it into a measurable amount. This is the bolometric mount which measures the power via a DC.

At high frequencies, the power becomes the reference value. The International System of Units (SI) has defined the watt (W) as the power unit. In our case, to quantify the relative levels of power, the decibel (dB) and decibels relative to one milliwatt (dBm) can be used.

These units are dimensionless and have an advantage in the calculation of gain or attenuation measurement systems.

The high frequency attenuation (HF) is usually measured using a heterodyne receiver intermediate frequency. The most used frequency is 30MHz because it is the most commonly used.

The idea is to achieve in a linear manner, the transposition of attenuation in high frequency to attenuation at a lower frequency.

As part of our work on traceability of measurements of attenuation. We propose a method to determine the desired attenuation by measuring HF power using bolometric method.

HF power measurement presents a major interest for several reasons; first, the heterodyne receiver requires annual calibration expensive and generates instrumentation and drift problems. Second, it is necessary for a metrology laboratory, according to

the ISO / IEC 17025 [10], possess several references to the same size. And finally, some types of commercial receivers used in the tester have seen their production stopped (evanescent wave receiver VM3). All these causes, pushing us to move towards the other calibration methods.

2 METHOD BY LINEAR SUBSTITUTION WITH INTERMEDIATE FREQUENCY

The concept of attenuation corresponds to a reduction of amplitude and a phase change of the voltage or current at the terminals of a load when a circuit element inserted between the source and the load.

Note that it confuses definitions related to the attenuation such as insertion loss, attenuation constant and intrinsic attenuation. It is therefore necessary, first of all, to establish a precise definition of the relevant size.

Among the different variables that can be defined to characterize a measure of attenuation, we will retain, for reasons of simplicity, the two that seem most important and whose definitions are:

- loss of inserting an attenuator
- Notion of attenuation

2.1 Insertion loss of an attenuator

If a source of any impedance delivers power P_1 also to any impedance load, and if the power delivered to the same load is reduced from P_1 to P_2 when the attenuator is inserted into the line, the insertion loss expressed in dB, is set to:

$$\text{Insertion loss} = 10 \log\left(\frac{P_1}{P_2}\right) \quad (1)$$

Thus defined, the insertion loss is not an exclusive characteristic quantity of the attenuator because it depends on the source and load impedances, it can be a positive or negative amount.

2.2 Definition of Attenuation

Attenuation is a special case of the insertion loss. By definition, attenuation in dB, is the correlation between power P_1 and power P_2 [16].

Along with:

- P_1 : The power delivered to a load perfectly adapted from a source perfectly adapted.

- P_2 : The power delivered to the same charge from the same source when the attenuator is inserted between them.

In contrast to the insertion loss defined above, the attenuation is a specific amount that is characteristic of the attenuator.

It is important to note that a transmission line element can produce an attenuation without power dissipation produced in this element. For example, a purely reactive component inserted in a line will change the power delivered by a source to a load. If the load and source are unsuitable, this change can be either a decrease or an increase in the power delivered to the load. On the contrary, if the source and load are adapted, attenuation can only be a positive quantity; since the condition for a source delivers maximum power to a matched load is that it is itself adapted. The attenuation produced by N purely reactive elements is sometimes called reflection losses.

In this case, the reflection losses are different depending on the direction in which it is used and therefore, the attenuation of this element will be different according to the direction of propagation.

2.3. Principle

Attenuation Radio Frequency is often measured using a heterodyne receiver. This receptor is an attenuator operating at a standard intermediate frequency (IF). The IF method is used as an intermediate frequency of 30MHz frequency because there are commercially for this first frequency-selective amplifiers, attenuators and other standards evanescent wave.

The IF calibration method is based on the determination of attenuation using a standard attenuator (heterodyne receiver). In this way, fixed attenuators, variable attenuators and customer equipment are calibrated by IF.

As part of our work on traceability of attenuation measurements. We propose a method for determining the desired attenuation by measuring the HF power using the bolometric method [10][11].

This method performs, in a linear manner, the transposition of attenuation in very high frequency (HF) to a lower frequency; it uses a heterodyne detector (Intermediate frequency attenuator).

The block diagram of the substitution is illustrated in series in Fig.1 and comprises:

- An RF source for the frequency measurement F_0 .
- A local oscillator frequency $F_0 \pm 30\text{MHz}$.
- A standard 30MHz Heterodyne receiver (VM7)
- A diode Mixer (Intermediate frequency mixer).

The principle of this method is shown in Fig.1:

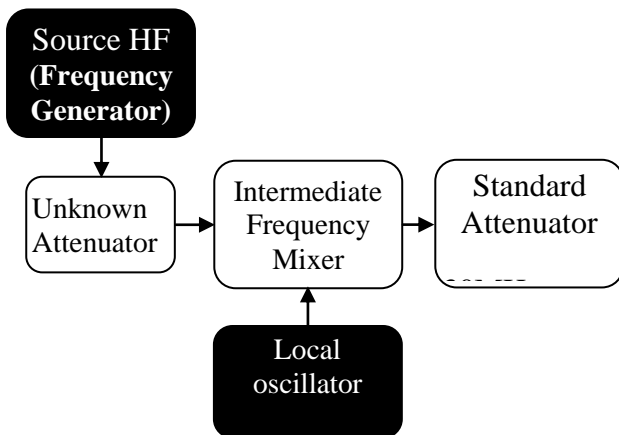

Fig.1: Substitution intermediate frequency

Thus, we realized this manipe in the metrology laboratory as shown in Figure 2



Fig. 2: Realization of the Substitution intermediate frequency

According to Fig.1, when two signals e_1 and e_2 are applied to a quadratic element (mixer), the output signal is set to:

From Eq.1, for output of the crystal; the following signals are:

- A continuous component proportional to a^2+b^2
- A frequency signal f_0-f_1 proportional to ab (useful signal).
- Signals at frequencies $f_1+ f_2, 2f_1, 2f_2$. (**)

These signals (**) are eliminated by the provision of a low-pass filter incorporated in the output of the crystal, there is only the DC component and the useful signal.

The method of substitution intermediate frequency has a span of about 60 à80dB according to the characteristics of the equipment used.

As part of validation of calibration methods, substitution method requires, firstly, annual calibration expensive and generates instrumentation and drift problems. In practice, as soon as the measurement frequency exceeds about 1GHz, oscillator stability is not sufficient for this difference is maintained 30MHz function of time. The attenuation values are unstable. On the other hand, the heterodyne receivers used in the tester saw output arrested. So all these reasons lead us to design other calibration methods according to the ISO / IEC 17025 part 5.6 measurement traceability page 18 [10].

3 FIXED ATTENUATION BY VARYING POWER

The power variation method is based on a physical model to generate a standard computable; it can be adopted as a reference method in the range of 0 to 20 dB [3].

3.1. Principle

The RF power is typically measured by converting continuous form (DC) as a voltage, current or resistance change. The idea is to measure the power dissipated in a power meter before and after insertion of the attenuator calibration.

We measure the power loss in a meter before and after insertion of the attenuator to be calibrated, Denoting by P_1 and P_2 respectively the powers that be dissipated in a matched load before and after insertion of the attenuator, then the introduced attenuation A is expressed by Eq.4:

The value of attenuation is obtained by power ratio:

$$A_{dB} = 10 \log_{10} \frac{P_1}{P_2}.$$

3.2 Diagram measurement

The corresponding measurement setup is shown by Fig.2:

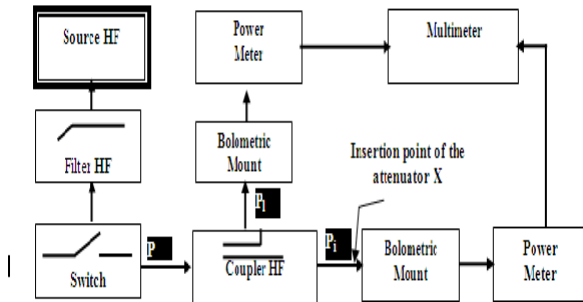

Fig.3 Measurement by DC power variation for fixed attenuator

** P_i : incident power; P_l : lateral power; P : power of the source.

$P_1 = \frac{P_{l1}}{P_{i1}}$ (Without attenuator) and $P_2 = \frac{P_{l2}}{P_{i2}}$ (with attenuator)

In terms of the absence of mismatches:

$$10 \log\left(\frac{P_{l1}}{P_{l2}}\right) + 10 \log\left(\frac{P_{i2}}{P_{i1}}\right) = A \quad (1) \quad (4)$$

With

$$(V_3^2 - V_4^2) / 4R_1K_1 = P_{i1} \quad (1) \quad (5)$$

V_4 =RF voltage of the mount with power HF (without attenuator).

V_3 = RF voltage of the mount without power HF (without attenuator).

R_1 = Resistance of balance of the mount (without attenuator).

K_1 = calibration factor of the mount (without attenuator).

$$2V_{1comp} ((\Delta V_1 - \Delta V_{01}) - \Delta V_1^2 + \Delta V_{01}^2) / (4R_2K_2) = P_{i2} \quad (6)$$

The Voltage V_{ref} (1) and V_{comp} (2) are shown in the power meter as shown in Figure 5:

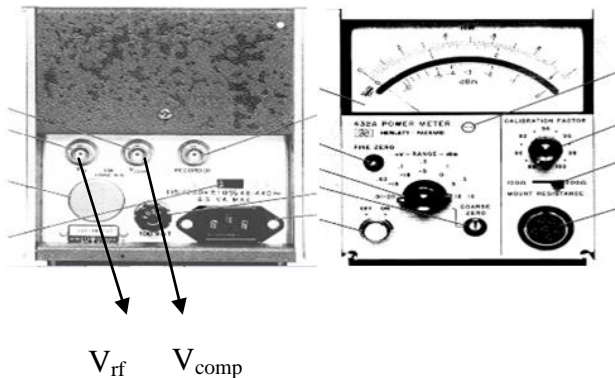

Fig.4 Power meter 432A

Then V_{RF} Input. Connected directly to RF bridge and V_{COMP} Input. Connected directly to compensation bridge. Also used for precision power measurements.

The power P_{i2} is measured when we insert the attenuator.

V_{1comp} = compensation voltage of the mount (with attenuator).

ΔV_1 = voltage ($V_{comp}-V_{RF}$) of the mount with power HF.

ΔV_{01} = voltage ($V_{comp}-V_{RF}$) of the mount without power HF.

R_2 = Resistance of balance of the mount (with attenuator).

K_2 = calibration factor of the mount (with attenuator).

The realization of the method adopted is as shown in Figure 5:

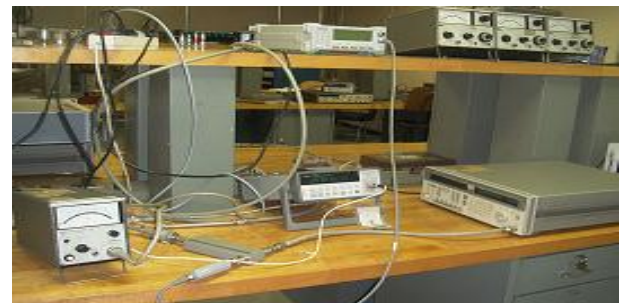

Fig.5. Realization of the power variation

According to the figure5, to determine the power substituted DC measurement two cycles are needed: a first cycle done without power HF (High Frequency) followed by a second with HF power. The Wheatstone bridge is used to hold the thermistor bolometer bridges the same value from one cycle to another.

After determining the powers without HF and HF, one makes the ratio of powers in order to identify the desired attenuation.

4. MEASUREMENT RESULT

The measurement is the set of operations designed to determine the attenuation value specified experimental conditions.

In the laboratory, we made a series of measurement for fixed attenuators 10 and 20dB, every time we simulate the reflection factor of the attenuator by exploiting the vector network analyzer and each time the corresponding curves are traced by comparing with all the usual method FI.

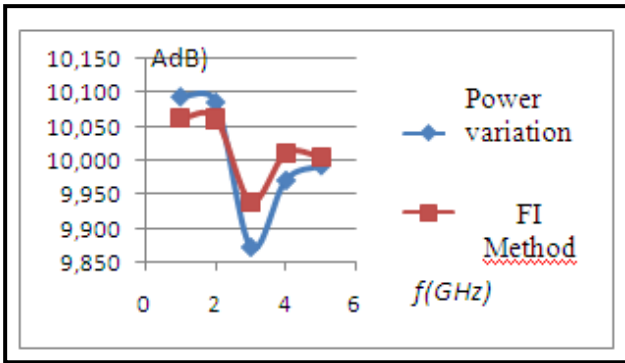

Fig.6. Attenuator 10dB

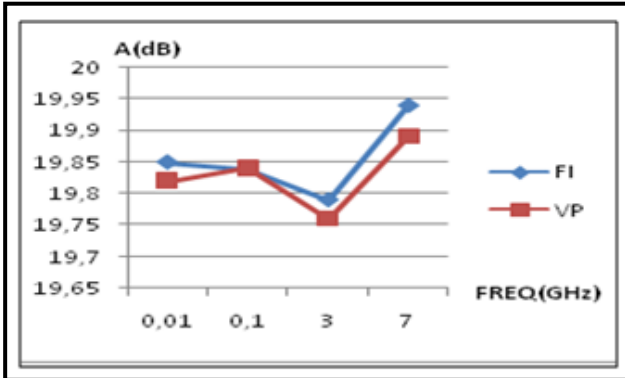

Fig.7: Attenuator 20dB

The figures (fig.6 and fig.7) show that the maximum deviation between the values measured by VP (power variation) and the values obtained by the IF method does not exceed 0.05. It is found that the results are acceptable compared the IF method.

To determine the uncertainty of such an attenuator, we must to determine the reflection factor using the software network analyzer: Intuilink VNA.

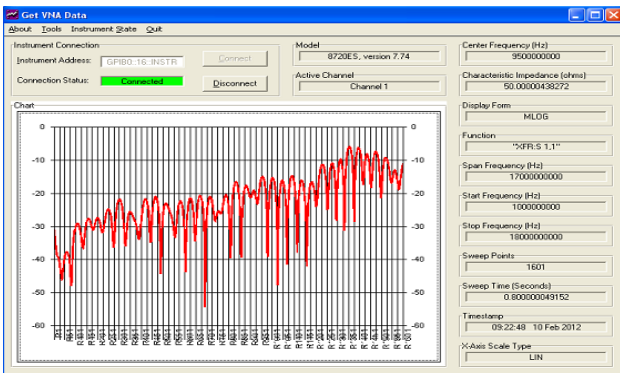

Fig. 8: Simulation of the return Loss(RL)for attenuator 10 dB by sweeping of frequency of 1GHz until 10GHz

Where

$$- 20 \log(|\Gamma|) = RL_{dB} \quad (6)$$

The Fig.8 shows that the values of the reflection factor will be important from 7 GHz which affect the measurement attenuation.

Therefore, it is essential at all calibration and whatever the method used to minimize the reflection factors and the mismatch by the uses of masking attenuators (usually 2 attenuators 10dB are used).

4.1 Estimation of measurement uncertainty

The uncertainty budget is the process leading to estimate the measurement uncertainty [10] [7].

This process takes into account the full analysis of the measurement process: obviously measured quantities, taking into account factors of influence and corrections to the result announcement. [9]

4.2 Analysis of components of uncertainty

In the absence of mismatch terms, the expression of the attenuation is:

$$\underbrace{\left[\frac{2V_{1comp} (\Delta V_1 - \Delta V_{01}) - \Delta V_1^2 + \Delta V_{01}^2}{(V_4^2 - V_3^2)} \right]}_{(1)} \cdot \frac{P_{i1}}{P_{i2}} = A_{rapport} \quad (7)$$

The term (P_{i1}/P_{i2}) is very near to unity (lateral power), it determines the power side, and the only term uncertainty is to consider the fluctuation of the voltmeter is statistically estimated uncertainty (type A).

The first term corresponds to incident powers; Applying the partial derivatives :

$$\underbrace{\frac{\Delta A_1}{A_1}}_{(1)} + \underbrace{\frac{\Delta(R1/R2)}{(R1/R2)}}_{(2)} + \underbrace{\frac{\Delta(K1/K2)}{(K1/K2)}}_{(3)} = \frac{\Delta P_{i2} / P_{i1}}{P_{i2} / P_{i1}} \quad (8)$$

Where

$$\frac{\Delta \left(\frac{2V_{1comp} (\Delta V_1 - \Delta V_{01}) - \Delta V_1^2 + \Delta V_{01}^2}{(V_4^2 - V_3^2)} \right)}{\left[\frac{2V_{1comp} (\Delta V_1 - \Delta V_{01}) - \Delta V_1^2 + \Delta V_{01}^2}{(V_4^2 - V_3^2)} \right]} = \frac{\Delta A1}{A1} \quad (9)$$

(1) Represents the uncertainty on the measurement reports of tensions.

(2) Determines the change of equilibrium of the bridge resistance as a function of the RF power.

(3) Represents the uncertainty due to the linearity of the calibration factor of the frame according to the RF power

And considering all the uncertainty due to the influence of mismatch for the case of a fixed attenuator, the expression of the standard deviation is:

$$[2\Gamma_m^2\Gamma_g^2(1 + 1/A_0)^2 + 2(\Gamma_m^2 + \Gamma_g^2)\Gamma_x^2]^{1/2} = \sigma \quad (10)$$

Besides, measurement is repeated to generate uncertainty due to stability, repeatability and reproducibility (all by changing the operator).

The final result to estimate the measurement uncertainty:

$$\sqrt{A_1^2 + A_2^2 + A_3^2 + BL_1^2 + BL_2^2 + BL_3^2 + BL_4^2} = U_c \quad (11)$$

With:

Ai: Type A evaluation of measurement Uncertainty(evaluation of a component of measurement uncertainty

by a statistical analysis of measured quantity values obtained under defined measurement conditions[5])

Bli: Type B evaluation of measurement Uncertainty(evaluation of a component of measurement uncertainty determined by means other than aType A evaluation of measurement uncertainty[5]).

In fact, we found the absolute uncertainty for fixed coaxial attenuators as illustrated in this table:

Table 1: MAGNITUDE UNCERTAINTIES

Frequency (GHz)	Magnitude uncertainties		
	Range(dB)	Absolute uncertainty	Method
0.01 to 10	0;3;6;10 and 20	0.017+0.36 Γ_x	Measured by varying the power
		0.025+0.41 Γ_x	Measured by the IF method

Table1 shows that the adopted method was improved measurement uncertainty compared to the conventional method for fixed attenuators.

We see an improvement in the uncertainty calculation method since this power variation is extremely simple to implement and it returns to the

original definition of attenuation and its relations to power.

Thus, we can consider this method a means of verification and intercomparison between laboratories.

4.3 Validation of results

The validation of this method is defined as "Validation is the confirmation by examination and the provision of objective evidence that the particular requirements for a specific intended use are fulfilled." ISO / IEC 17025 [6].

ISO/IEC 17025 requires validation method when the laboratory uses a non-standard or outside the scope of the standard.

We must therefore show that the method implemented by the laboratory is suitable for intended use.

The performance of a method can be expressed using features such as selectivity, linearity, repeatability, robustness.

To interpret the results, a standard deviation was calculated following the methodology described in paragraph A 2.1.4.e ISO / IEC 43-1 [6] guide [9] to achieve the selectivity of the adopted method:

$$E_n = \frac{x - X}{\sqrt{U_{lab}^2 + U_{ref}^2}} \quad (12)$$

Where is the U_{lab} expanded set associated with the value of the participant x and U_{ref} is the expanded uncertainty associated with the X accepted reference value of the reference laboratory [7] [9].

Applied to the present case for the 3 dB attenuator at 10MHz, this formula becomes:

$$E_n = \frac{A_{VP} - A_{FI}}{\sqrt{U_{VP}^2 + U_{FI}^2}} \quad (13)$$

Where

A_{VP} : Attenuation by power variation.

A_{FI} : Attenuation by the IF method.

U_{VP} Uncertainty of the power variation method.

U_{FI} : Uncertainty of the FI method.

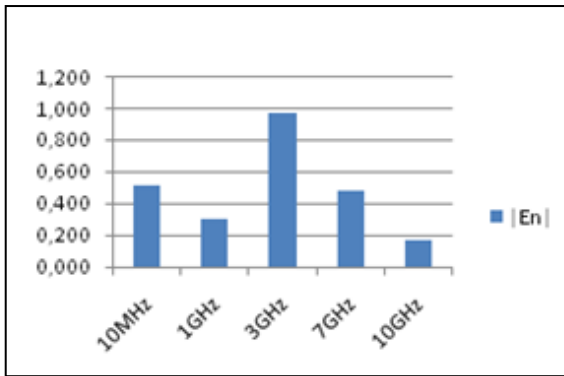

Fig.9. Statistical test for attenuator 20dB

According to the LAB-GTA, $E_n < 1$ value provides objective evidence that the uncertainty estimate is consistent with the definition of the expanded uncertainty given in the GUM [7] [9].

This performance statistics allows us to conclude that the results obtained by power variation can be validated against the conventional method.

5. VARIABLE ATTENUATION BY VARYING POWER

In the case of a variable attenuator, one is interested in the variation of attenuation between a reference point (generally 0 dB) and a point corresponding to a read on a scale (the case of continuously variable attenuator) or position of a switch (if the attenuator is variable).

5.1. Principle

We carried the same test setup (Figure 1) and replaced the fixed attenuator with a variable attenuator (plot). The same steps of steps are followed to obtain the substituted powers in order to achieve the desired attenuation.

5.2. Presentation of results

We have achieved the manipe by using a variable attenuator (8495b) at different frequencies (10 MHz, 100 MHz and 1GHz 7GHz):

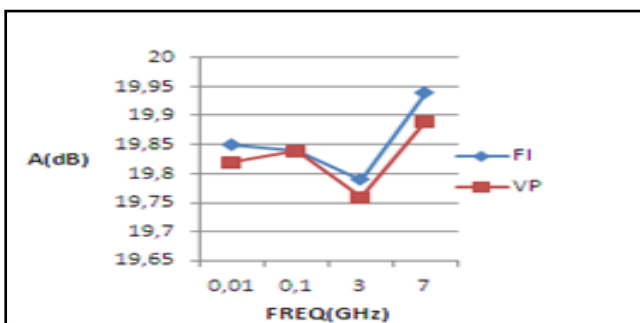

Fig.10. Variable attenuator by two methods

From Figure 10, the maximum difference between the values found by VP and the measures already made by FI does not exceed 0.05. So the results are already found tolerable compared the IF method.

5.3 Validation of the results

It is often necessary to transform the results measured performance statistics to facilitate interpretation and to allow comparison with known methods (paragraph B.3.1.1 of the European standard EN ISO / CEI 17043).

One among the performance statistics is used z scores (zeta).

The z-scores are calculated using the equation1

$$Z = \frac{x - X}{\sigma} \quad (14)$$

When

σ : Standard deviation for aptitude evaluation (participant) [6].

x : Attenuation by power variation.

X : Attenuation by the IF method.

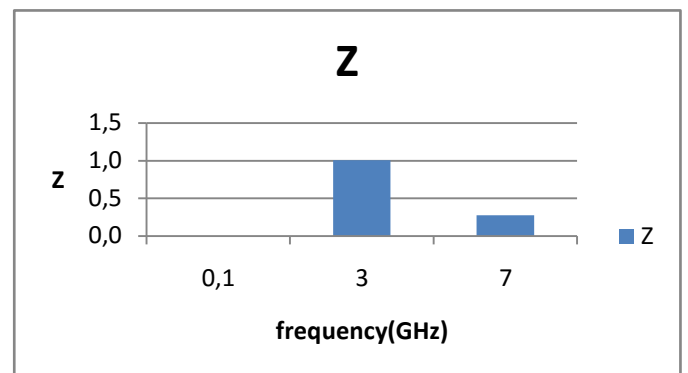

Fig.11.Statistical test for attenuator 20dB

According to the 17043 standard, a value of $|z| \leq 2$ provides objective evidence that the "satisfactory" performance and generates no signal [6].

This performance statistics allows us to conclude that the results obtained by power variation can be validated against the standard method FI.

6 Conclusion

This article deals with the establishment of a chain of metrological traceability for the attenuation measurement using bolometric bridge. This method adopted and increases confidence that the user can give the results of Measures.

The simulation curves of factor of reflection and calculating measurement uncertainty show a good correspondence between the model and the measurement and statistical treatment of this method and especially the standard deviation and zeta shown that the results are validated [5].

Although the results presented are limited to 20dBm since the bolometric mounts cover a very wide dynamic power: -30dBm to + 20dBm, and the preparation time is far longer. We can consider this method a means of verification and intercomparison between laboratories.

The prospect of this article focuses on several points. The first point is to eliminate the fluctuations of the source and the influence of the mismatch of the generator by using a suitable directional coupler.

The second point is used to eliminate losses in the bolometric mounts using a recently introduced in some commercially available power meters configuration.

The improvement of the uncertainty of the adopted method will use this method as a method for cross calibration of fixed attenuators, variable all by ensuring traceability to SI units [17][15] (Fig.12)

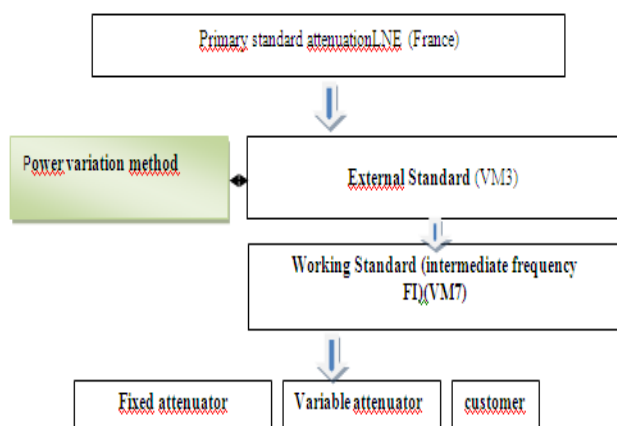

Fig.12. Metrological Traceability Chain of the parameter "attenuation"

References:

- [1] D.Allal et B.Mellouet, "Traçabilité au SI des mesures effectuées à l'aide d'analyseurs de réseaux vectoriels", 13ème Congrès International de Métrologie, Lille, 18-21 juin 2007, Paris.
- [2] M. désenfant et M. Priel, Cédric Rivier, "De la validation des méthodes d'analyse à l'évaluation de l'incertitude des résultats de mesure", BNM-LNE, Paris.
- [3] ISO / TS, "Guide to the use of repeatability, reproducibility and trueness estimates in measurement calibration", 2004.
- [4] ISO / TS, "Guide to the use of repeatability, reproducibility and trueness estimates in measurement calibration", 2004.
- [5] NF X 07-001, "Normes fondamentales - Vocabulaire international des termes fondamentaux et généraux de métrologie", (VIM), AFNOR, 2012.
- [6] NF EN ISO/CEI 17043, "Evaluation de la conformité – Exigences générales concernant les essais d'aptitude", Avril 2010, AFNOR.
- [7] NF EN ISO/CEI 17025, "Exigences générales concernant les compétences des laboratoires d'étalonnages et d'essais", Septembre 2005, AFNOR.
- [8] A .Kazemipour, "nouvel étalon primaire de puissance HF, DC-26.5GHz", JNM, 2003.
- [9] S. Seghier et N. Benahmed, "Analyse et conception d'un coupleur coaxial rectangulaire à conducteurs internes circulaires par la méthode des éléments finis", SCIENCE 02(3) (2006), pp : 300 – 313.
- [10] EA-4/02, « Expression of uncertainty of measurement in calibration», European co-operation for Accreditation, 2004.
- [11] EA-4/16, « Lignes directrices d'EA pour l'expression de l'incertitude des résultats d'essais quantitatifs », European co-operation for Accreditation, Avril 2004.
- [12] S. M. Abd-Elazim, and E. S. Ali, "Optimal Power System Stabilizers Design for Multimachine Power System Using Hybrid BFOA-PSO Approach", Int. J. of WSEAS Transactions on Power Systems, Vol. 8, No. 2, April 2013, pp. 85-94.
- [13] S. M. Abd-Elazim, and E. S. Ali, "Synergy of Particle Swarm Optimization and Bacterial Foraging for TCSC Damping Controller Design", Int. J. of WSEAS Transactions on

Power Systems, Vol. 8, No. 2, April 2013, pp. 74-84.

- [14] E. S. Ali, and S. M. Abd-Elazim, “*Power System Stability Enhancement via Bacteria Foraging Optimization Algorithm*”, Int. Arabian Journal for Science and Engineering (AJSE), Vol. 38, No.3, March2013, pp.599-611.
- [15] K.Wong, “*Traceability of vector network analyzer measurements*”, IEEE Xplore, 9-12 Dec.2008,pp.157-167.
- [16] A.Widarta, H. Iida and T. Kawakami “*Attenuation-Measurement System in the Frequency Range of 18–40 GHz*”, IEEE Transactions on Instrumentation And Measurement, VOL. 56, NO. 2, APRIL 2007.
- [17] N. Ridler¹, R. Clarke², M. Salter¹ and A. Wilson¹ “*Traceability to national standards for S-parameter measurements in waveguide at frequencies from 220 GHz to 330 GHz*”, IEEE Xplore, 1-2 Dec. 2011, pp. 1 – 6.